

**Blank Page**

(for page alignment only)



# HOBIE CAT ILLUSTRATED PART GUIDES

## WAVE, GETAWAY, 14, 16, 17, 18 & 20

Illustrated Part Guides for TIGER, FOX, H21 Sport Cruiser, Trifoiler and Hobie One Mono Hulls are available on-line at

[www.hobiecat.com](http://www.hobiecat.com)



STANDARD WAVE VERSION (CAR TOPPABLE)  
CLUB WAVE VERSION—ITEMS LISTED ONLY IF DIFFERENT FROM STANDARD WAVE MODEL.

### MAST CHANGE INFORMATION

#### OLD STYLE:

SERIAL NUMBER 0 THROUGH 1437  
MAST ASSEMBLY 38581000 IS NO LONGER AVAILABLE (SEE NEW STYLE).  
OLD STYLE MAST BASE 10640011 (HOBIE14 CUP)

#### NEW STYLE:

SERIAL NUMBER 1438 AND HIGHER  
NEW MAST ASSEMBLY 38581041

NEW PARTS (\*Required to retrofit new mast to old style boat):

- 38171001 \*NEW MAST STEP CASTING (FLAT TOP / THREADED FOR POST)
- 8011231 \*RIVET (4)
- 50212301 \*NEW STEP BALL
- 38170001 \*NEW STEP POST
- 38641001 NEW MAST BASE (CUP)
- 8020451 \*STEP PIN

#### REPLACEMENT HULL (W/O GRAPHICS)

**STANDARD WAVE**  
PORT/LEFT 38010001  
STARBOARD/RIGHT 38020001

**CLUB WAVE**  
PORT/LEFT 39010001  
STARBOARD/RIGHT 39020001

- |                           |                             |                               |
|---------------------------|-----------------------------|-------------------------------|
| DECAL—OLDER               | DECAL—(98-99)               | DECAL—(2000)                  |
| 12450012 *HOBIE CAT* TEAL | 12450081 CURL TEAL PORT     | 12450101 CURL PURPLE PORT     |
| 12450022 *WAVE* CORAL     | 12450091 CURL TEAL STBD     | 12450111 CURL PURPLE STBD     |
| 12450032 LARGE CURL CORAL | 12451001 HOBIE DIAMOND TEAL | 12451011 HOBIE DIAMOND PURPLE |
| 12450042 SMALL CURL TEAL  | 12451151 WAVE SM TEAL       | 12452151 WAVE SM PURPLE       |

See parts listing for newer graphics.

### RUDDER ASSEMBLY

\* = SUB ASSEMBLY PART / INCLUDED WITH CASTING

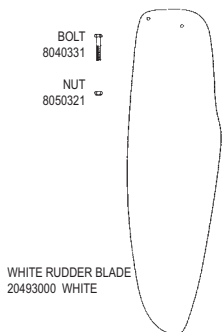
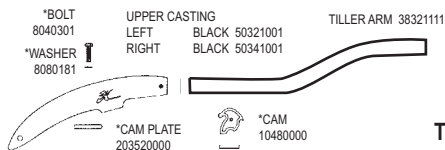

- \*CAM PLATE 203520000
- \*CAM 10480000
- \*PIN 50312301
- UPPER CASTING
- LEFT BLACK 50321001
- RIGHT BLACK 50341001
- TILLER ARM 38321111
- LOWER CASTING BLACK 50322001
- RUDDER BUSHING UPPER 8062001
- LOWER 38360001
- \*ADJUSTMENT SCREW 8032001
- \*PLUNGER 50312201
- \*SPRING 10430000
- \*TENSION SCREW 60450000

### TENDON TILLER CONNECTOR ASSEMBLY

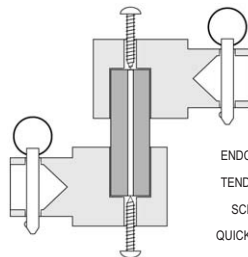

- 39522001 NEW TENDON STYLE  
TILLER CONNECTOR UPGRADE  
INCLUDES TILLER CROSS BAR AND ALL  
TILLER CONNECTOR FITTINGS
- ENDCAP 37561001
- TENDON 37561011
- SCREW 8030701
- QUICK PIN 8020461
- LANYAD 37660091

### 1954 CLUB TILLER END CAP ASSEMBLY

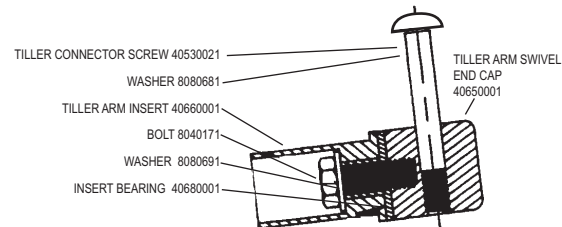

- 1954 TILLER CONNECTOR UPGRADE  
INCLUDES TILLER CROSS BAR AND ALL  
TILLER CONNECTOR FITTINGS
- TILLER CONNECTOR SCREW 40530021
- WASHER 8080681
- TILLER ARM INSERT 40660001
- BOLT 8040171
- WASHER 8080691
- INSERT BEARING 40680001
- TILLER ARM SWIVEL END CAP 40650001

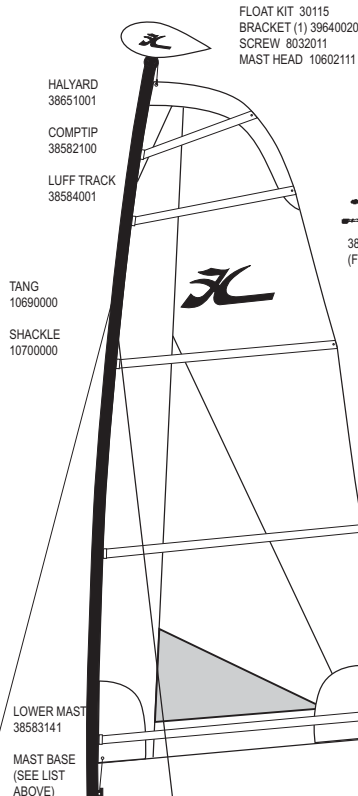

- FLOAT KIT 30115
- BRACKET (1) 39640020
- SCREW 8032011
- MAST HEAD 10602111

MAIN SAIL 3899XXXX  
SEE SEQUENTIAL PRICE LIST  
OR SAIL COLOR SELECTION SHEET, PAGE 21

- HALYARD 38651001
- COMPTIP 38582100
- LUFF TRACK 38584001

- TANG 10690000
- SHACKLE 10700000

- BATTEN #5 36"
- BATTEN #4 50"
- BATTEN #3 66 7/8"
- BATTEN #2 77 7/8"
- BATTEN #1 82 3/8"

38016001 HOBIE WAVE BATTEN SET  
(FOR INDIVIDUAL BATTENS SEE UNIVERSAL BATTENS ON PAGE 27)

- \*S\* HOOK 38900031
- SHACKLE 38900051

- UPPER BLOCK 38900061

RM516BLU X 35'

- LOWER BLOCK 38900071

# STANDARD WAVE

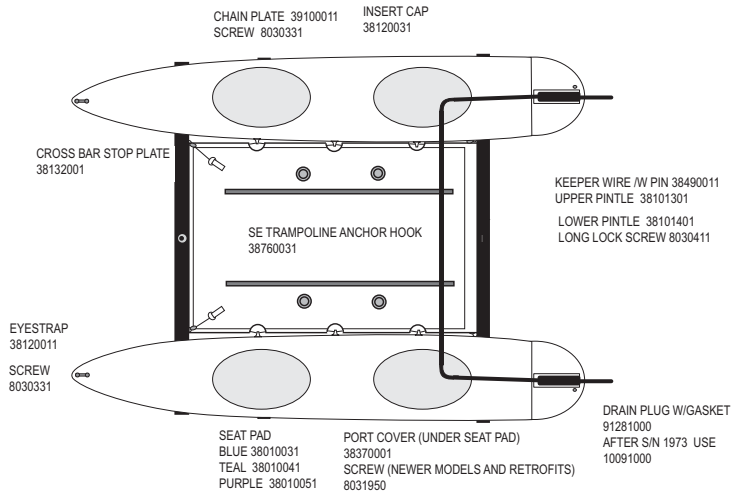

Wave Rivet Guide ( ) Quantity needed to fasten part	
<b>Mast</b>	
Head	8010131 (2)
Halyard Hook	8010181 (2)
	8011291 (2)
Tang	8010181 (6)
	8011291 (6)
Halyard Cleat	8010121 (2)
Base	8010131 (3)
<b>Rear Crossbar</b>	
Pad Eye	8010181 (2)
<b>Front Crossbar</b>	
Mast Step	8011231 (4)
<b>Rudder Assembly</b>	
Upper Casting	8010131 (2)
(Underside)	8011231 (1)
Tiller End Cap	8010131 (2)
<b>Sail</b>	
Headboard	8010020 (16)
Tack/Clew plate	8010020 (6)
Pocket Protector	8010020 (4)
(Requires setting machine-not available as hand tool)	

**'97-NEWER**  
(SN 1438-ABOVE)  
FORWARD CROSSBAR  
38131041

MAST STEP CASTING  
38171001

POST (THREADED)  
38170001

BALL  
50212301

BASE PIN  
8020451

**'96-OLDER**  
MAST STEP CASTING  
10170011

MAST STEP LINK KIT  
21380001

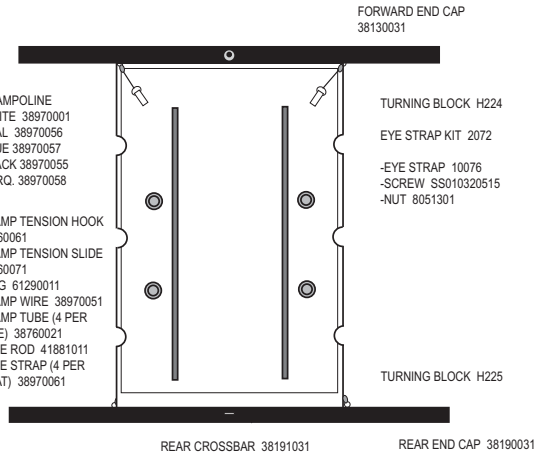
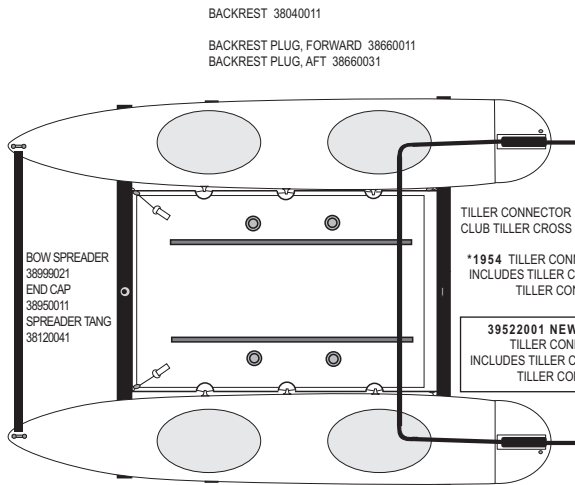

# CLUB WAVE ( CLUB WAVE VERSION-ITEMS LISTED BELOW ONLY IF DIFFERENT FROM STANDARD WAVE MODEL. )

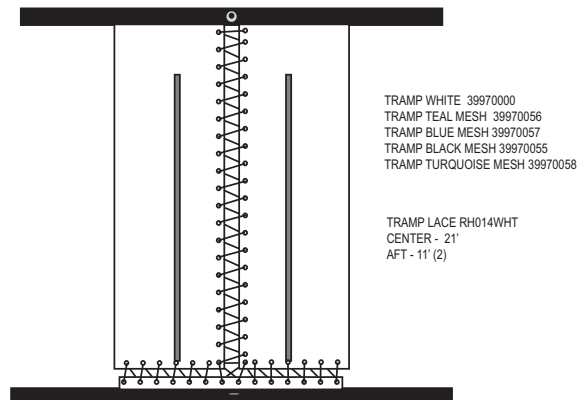
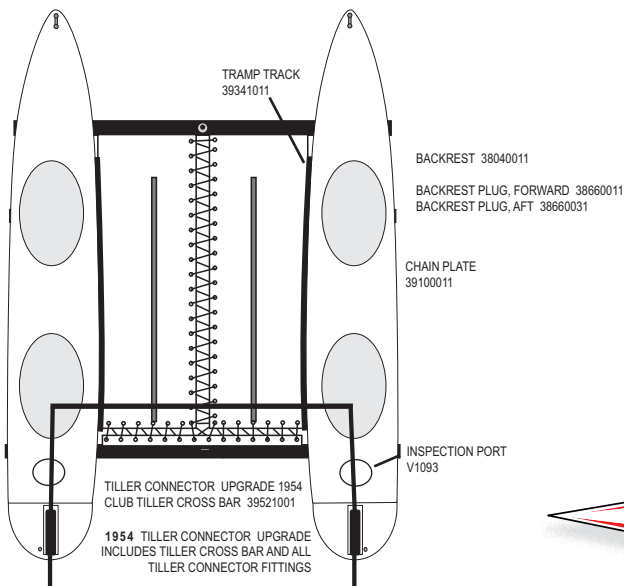

To order from your nearest HOBIE dealer call  
**1 (800) HOBIE-49**  
[www.hobiecat.com](http://www.hobiecat.com)



TANG  
20690000  
SHACKLE  
20700001

HALYARD  
37651001  
MAST ASSEMBLY  
37610000  
COMPTIP  
37611100  
LUFF TRACK  
38584001  
LOWER MAST  
37583141  
MAST BASE  
37641001  
STEP PIN  
50406301

**WIRES**  
SHROUD 37790001  
SHROUD ADJUSTER 20830010  
BRIDLE 37822011  
FORESTAY ASSY 37810001  
FORESTAY ADJUSTER 37830020  
TRAPEZE WIRES 1478B  
TRAPEZE RIG KIT 37140001  
(COMPLETE KIT)

FLOAT 37600000  
SCREW 8032011  
MAST HEAD 37601001

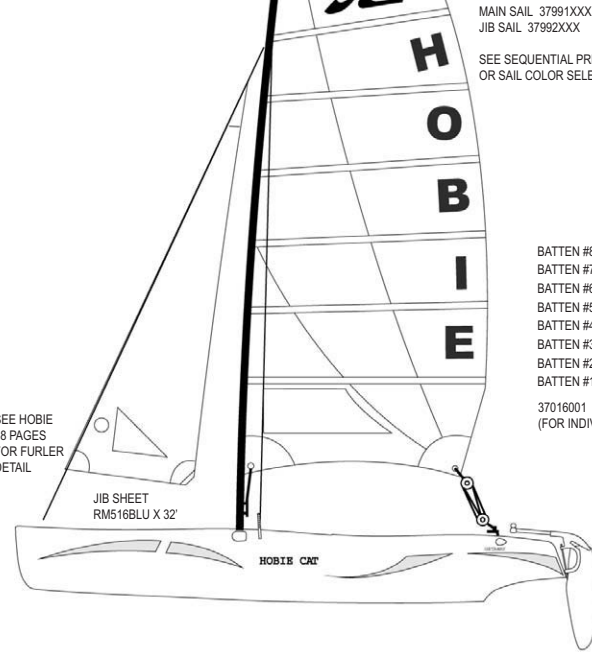

MAIN SAIL 37991XXX  
JIB SAIL 37992XXX  
SEE SEQUENTIAL PRICE LIST  
OR SAIL COLOR SELECTION SHEET, PAGE 21

BATTEN #8 34 1/2" (Blue)  
BATTEN #7 55"  
BATTEN #6 69"  
BATTEN #5 77 3/4"  
BATTEN #4 84 1/4"  
BATTEN #3 88 3/4"  
BATTEN #2 90 3/4"  
BATTEN #1 92"

37016001 BATTEN SET  
(FOR INDIVIDUAL BATTENS SEE UNIVERSAL BATTENS ON PAGE 27)

SEE HOBIE  
18 PAGES  
FOR FURLER  
DETAIL

JIB SHEET  
RM516BLU X 32'

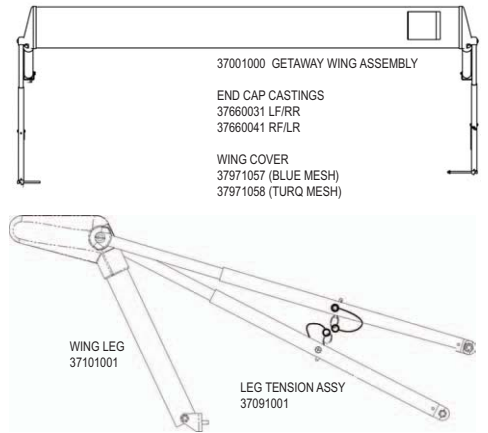

37001000 GETAWAY WING ASSEMBLY

END CAP CASTINGS  
37660031 LF/RR  
37660041 RF/LR

WING COVER  
37971057 (BLUE MESH)  
37971058 (TURQ MESH)

WING LEG  
37101001

LEG TENSION ASSY  
37091001

UPPER BLOCK  
37900021

MAIN SHEET  
RM038RED X 38'

LOWER BLOCK  
37900011

### TILLER CONNECTOR ASSEMBLY

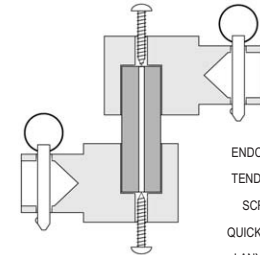

ENDCAP 37561001  
TENDON 37561011  
SCREW 8030701  
QUICK PIN 8020461  
LANYAD 37660091

BOW SPREADER  
37500001

END CAP  
37500031

COOLER LID  
37370021

MOUNT  
GASKET  
37370031

SEE HOBIE 16  
DIAGRAMS  
FOR MAIN  
TRAVELER CAR  
DETAILS

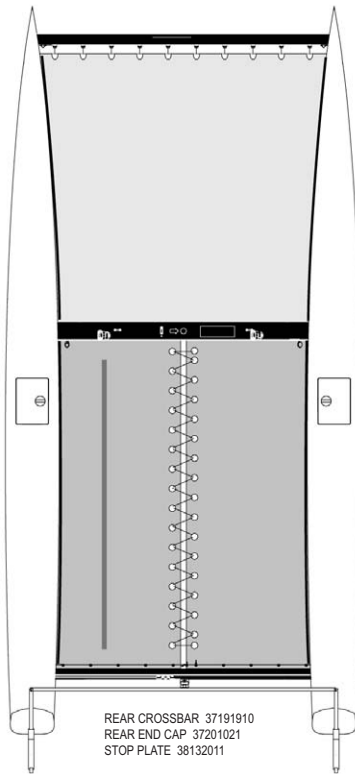

### REPLACEMENT HULL (W/O GRAPHICS)

PORT/LEFT 37010001  
STARBOARD/RIGHT 37020001

TRAMP FWD 37980055  
TRAMP TRACK FWD 37342011

FWD CROSSBAR 37131910  
STOP PLATE 38132011

FWD END CAP (LT) 37151021  
FWD END CAP (RT) 37151031

MAST STEP STUD 37170001  
MAST STEP BALL 30110001  
WASHER 8080711  
NUT 8050151

CHAIN PLATE 39100011

TRAMP BLUE MESH 37970057  
TRAMP TURQ MESH 37970058  
TRAMP TRACK MAIN 37341011

KEEPER WIRE /W PIN 38490011  
UPPER PINTLE 38101301  
LOWER PINTLE 38101401  
LONG LOCK SCREW 8030411

REAR CROSSBAR 37191910  
REAR END CAP 37201021  
STOP PLATE 38132011

TILLER CROSSBAR 37521001  
TILLER CROSSBAR  
(TENDON STYLE)  
TILLER 20551000  
(CUT TO 60")

### RUDDER ASSEMBLY

\* = SUB ASSEMBLY PART / INCLUDED WITH CASTING

\*BOLT 8040301  
\*WASHER 8080181  
UPPER CASTING LEFT BLACK 50321001  
UPPER CASTING RIGHT BLACK 50341001  
TILLER ARM 37321111



\*CAM PLATE  
203520000

\*CAM 10480000

BOLT 8040331  
NUT 8050321



WHITE RUDDER BLADE  
20493000 WHITE

\*PIN 50312301

LOWER CASTING BLACK 50322001

RUDDER BUSHING UPPER 8062001  
LOWER 38360001

\*ADJUSTMENT SCREW 8032001

\*PLUNGER 50312201

\*SPRING 10430000

\*TENSION SCREW 60450000

### H14 MAST

COMPLETE MAST ASSEMBLY, BLACK 10581100  
COMPTIP ASSEMBLY 10582100

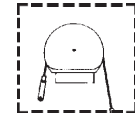

OLD STYLE  
MASTHEAD W/SHEAVE  
BLACK 10600011

MASTHEAD  
COMPTIP  
10602111

HALYARD SHACKLE 10670000  
SINGLE BALL SHANK 8063261  
STOP SLEEVE 8063271

HALYARD HOOK  
10680001

MAIN HALYARD ASS.  
(COMPTIP) 10657001

MAIN HALYARD ASSY (NON COMPTIP)  
10651001

CAP PLUG  
8090900

LUFF TRACK  
38584001

MAST TANG  
10690000

DANGER LABEL/WATCH  
FOR WIRES 13440010

**DANGER**  
ALWAYS USE EXTREME CAUTION WHILE  
RAISING AND LOWERING YOUR MAST. CONTACT  
WITH A POWER LINE COULD BE FATAL.

SAILFEEDER KIT 80100501  
SCREW 8031541

MAST CAUTION LABEL  
13440000

DOWNHAUL/HALYARD CLEAT  
10730000  
SCREW 8030111  
NUT 8051301

MAST BASE  
BLACK 10640011

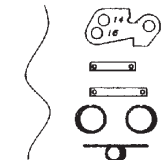

MAST STEP LINK KIT 21380001

VENT TUBE 10140000  
FOAM PLUG 10060000

### H14 HULL

SCREW  
8030301

BOW TANG  
20120000

LEFT (PORT) REPLACEMENT HULL-WHITE 10010001  
RIGHT (STBD) REPLACEMENT HULL-WHITE 10020001  
(SPECIFY CCM, HULL COLOR, STRIPING TYPE)  
(ALL HULLS COME WITH BLACK PYLONS)

COTTER PIN 8060111

NYLON RUDDER PIN 10881000

UPPER GUDGEON  
SCREW 50101301  
8030001  
WASHER 8080021

LOWER GUDGEON  
SCREW 50101401  
8030001  
WASHER 8080021

DRAIN HOUSING  
SCREW 10092000  
8031731

DRAIN GASKET 10092025

DRAIN PLUG W/  
GASKET 10091000

### H14 RUDDER

\*BOLT 8040301

\*WASHER 8080181

\* = SUB ASSEMBLY PART / INCLUDED WITH CASTING

\*CAM STOP PLATE 20352000

END CAP 10400010

STRAIGHT BLACK TILLER TUBE 10382010

ADJUSTABLE UPPER RUDDER CASTING  
BLACK LEFT (PORT) 10352011  
BLACK RIGHT (STBD) 10362011

BOLT 8040341

NUT 8050301

WHITE RUDDER BLADE 20493000  
RACER BLADE 20494000

\*CAM 10480000

\*PIN 10470000

ADJUSTABLE LOWER RUDDER  
CASTING BLACK 10412011

\*ADJUSTABLE SCREW 8032001

RUDDER LOCKING KIT  
10311900

\*PLUNGER 10440000

\*SPRING 10430000

\*DELRIN SCREW 60450000

### H14 SHROUDS, FORESTAY & BRIDLES

SHROUD SHACKLE 10700000

SHROUD  
BLACK 10792100

FORESTAY  
BLACK 10812101

NICOPRESS SLEEVE 8063761

THIMBLE 20800000

PIN AND RING  
SET 30303  
SEE PAGE 40

CLEVIS PIN 8020381  
ADJUSTER RING 20860000

CLEVIS PIN 8020381  
ADJUSTER RING 20860000

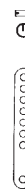

7 HOLE 1/4" STAY ADJUSTER  
20830010

10 HOLE 1/4" ADJUSTER  
20830020



SHACKLE 10700000

SHACKLES (FOR BOATS WITH  
BOW PLATES) 10870000  
IN PLACE OF TANGS

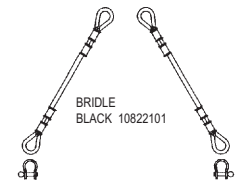

BRIDGE  
BLACK 10822101

### H14 FRONT CROSSBAR

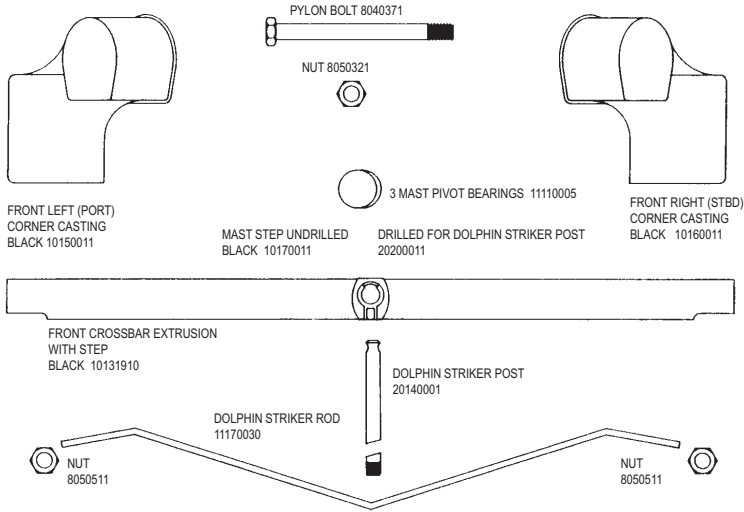

### H14 REAR CROSSBAR

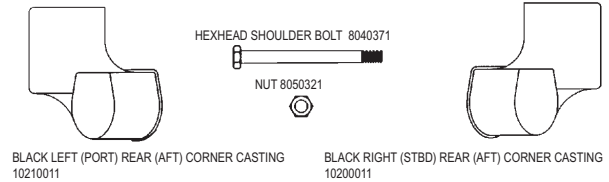
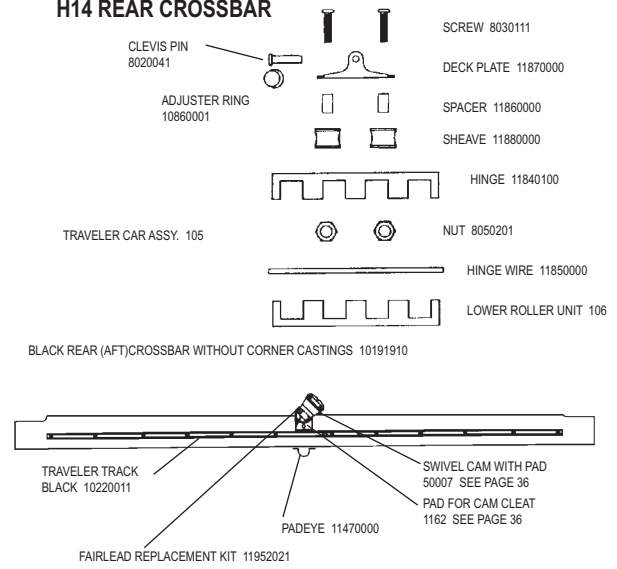

### H14 BLOCKS

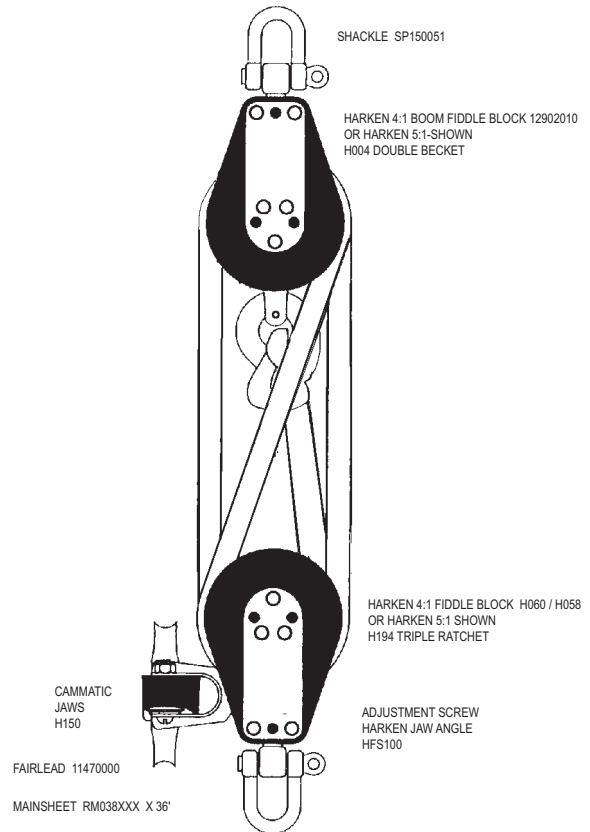

### H14 BOOM

BOOM ASSEMBLY  
BLACK 10720011

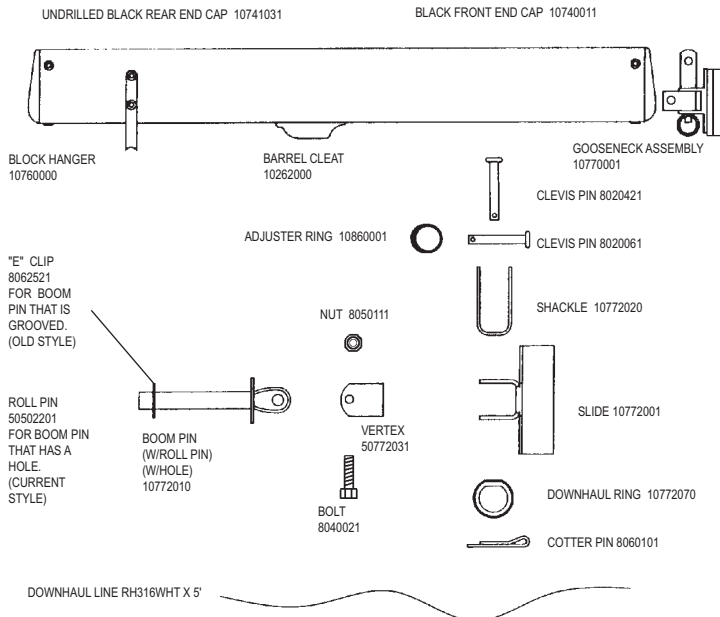

# H14 TRAMPOLINE

COMPLETE TRAMPOLINE (Does not include lace lines)  
 WHITE 10970000  
 BLACK MESH 10970055  
 TEAL MESH 10970056  
 BLUE MESH 10970057

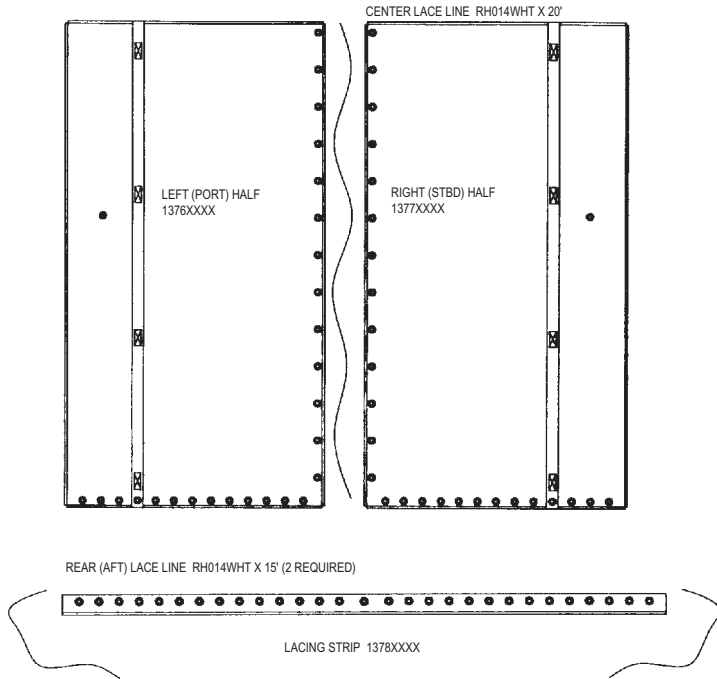

# H14 SAIL, BATTENS

MAIN SAIL, 1099XXXX  
 SEE SEQUENTIAL PRICE LIST  
 OR SAIL COLOR SELECTION SHEET, PAGE 21

HEADBOARD 68330011

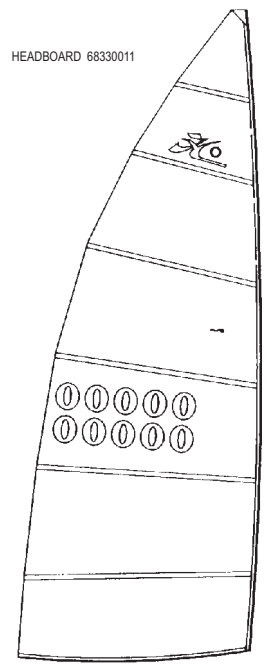
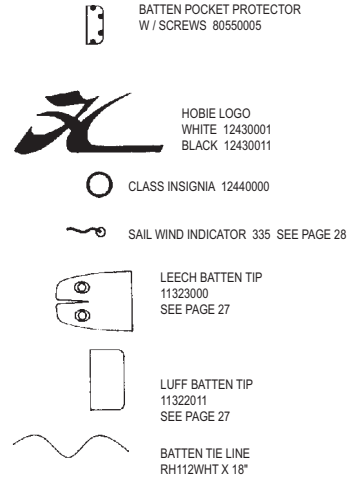

### 14" SAIL NUMBERS

	BLACK	WHITE
#0	12700030	12700000
#1	12710030	12710000
#2	12720030	12720000
#3	12730030	12730000
#4	12740030	12740000
#5	12750030	12750000
#6 & #9	12760030	12760000
#7	12770030	12770000
#8	12780030	12780000

TACK / CLEW PLATE SET 12240000

# H14 TILLER CROSSBAR AND EXTENSION

TILLER CONNECTOR KIT 11520005

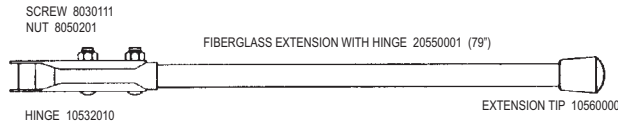
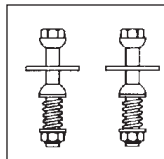

# H14 TURBO JIB

10992XXX  
 SEE SEQUENTIAL PARTS LIST

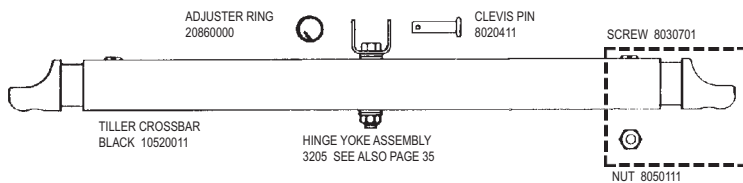
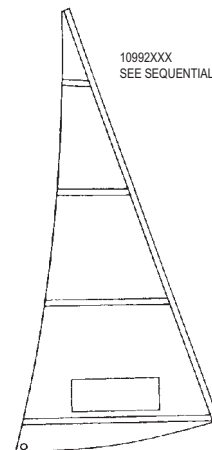

### H14 TURBO RIGGING KIT

TURBO RIGGING KIT 8020000

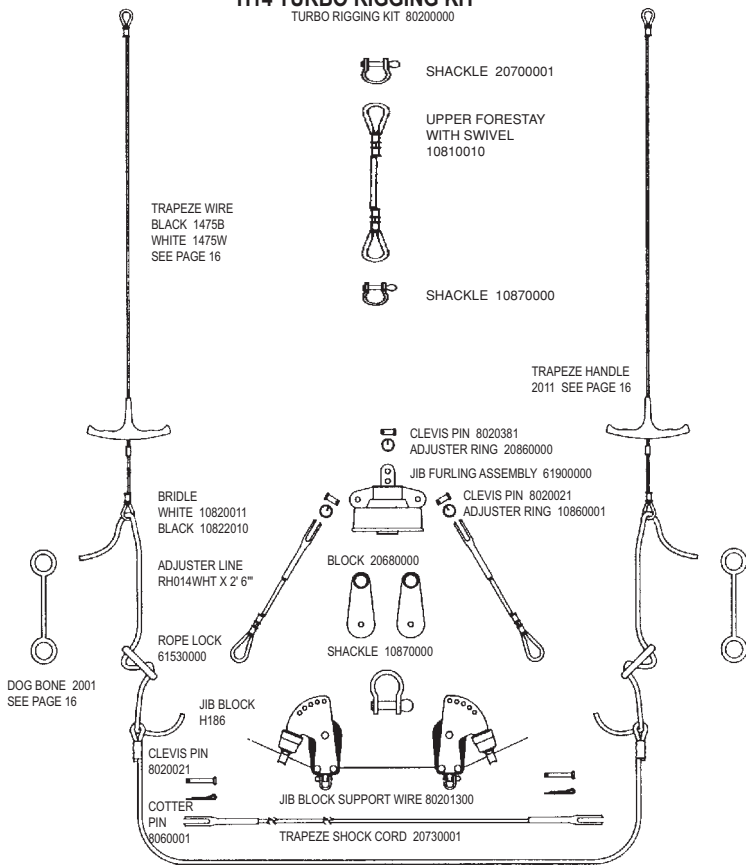

### H14 Rivet Guide

( ) = Quantity needed to fasten part

<b>Mast</b>	
Head	8010131 (2)
Halyard Hook	8010181 (2)
	8011291 (2)
Tang	8010181 (6)
	8011291 (6)
Halyard Cleat	8010121 (2)
Base	8010131 (3)
<b>Sidebar</b>	
Chain Plate	8010181 (3)
<b>Rear Crossbar</b>	
Corner Casting	8011231 (6)
Traveler Track	8010201 (18)
or	8010161 (18)
Pad Eye	8010181 (2)
Swivel Jam Cleat	8010201 (1)
	8031501 (2)
	8031231 (1)
	8050801 (1)
	8080101 (1)
<b>Boom</b>	
Front End Cap	8010131 (3)
Tang	8010181 (4)
Barrel Cleat	8010181 (2)
Block Hanger	8010181 (4)
Rear End Cap	8010131 (3)
<b>Front Crossbar</b>	
Mast Step	8011231 (4)
Corner Casting	8011231 (6)
<b>Rudder Assembly</b>	
Upper Casting	8010131 (2)
(Underside)	8011231 (1)
Tiller End Cap	8010131 (2)
<b>Sail</b>	
Headboard	8010020 (16)
Tack/Clew plate	8010020 (6)
Pocket Protector	8010020 (4)
(Requires setting machine-not available as hand tool)	

### H16 Rivet Guide

( ) = Quantity needed to fasten part

<b>Mast</b>	
Head	8010131 (4)
Halyard Hook	8010181 (2)
	8011291 (2)
Tang	8010181 (12)
	8011291 (12)
Halyard Cleat	8010121 (2)
Base	8010131 (3)
Downhaul Cheek Block	8010181 (4)
<b>Front Crossbar</b>	
Corner Casting	8011231 (6)
Mast Step	8011231 (4)
Jib Track	8010201 (6)
Swivel Jam Cleat	8010201 (1)
or	801016
Pad Eye	8031501 (2)
Swivel Jam Cleat	8031231 (1)
	8050801 (1)
	8080101 (1)
<b>Rudder Assembly</b>	
Upper Casting	8010131 (2)
(underside)	8011231 (1)
Tiller End Cap	8010131 (2)
<b>Boom</b>	
Front End Cap	8010131 (3)
Tang	8010181 (4)
Barrel Cleat	8010181 (2)
Block Hanger	8010181 (4)
Rear End Cap	8010131 (2)
<b>Rear Crossbar</b>	
Corner Casting	8011231 (6)
Traveler Track	8010201 (20)
Pad Eye	8010181 (2)
Swivel Jam Cleat	8010201 (1)
	8031501 (2)
	8031231 (1)
	8050801 (1)
	8080101 (1)
<b>Sail</b>	
Main Headboard	8010020 (16)
Tack/Clew Plate	8010020 (6)
Main Pocket Prtc	8010020 (4)
Jib Clew Plate	8010020 (16)
Jib Pocket Prtc	8010020 (3)

### H16 HULL

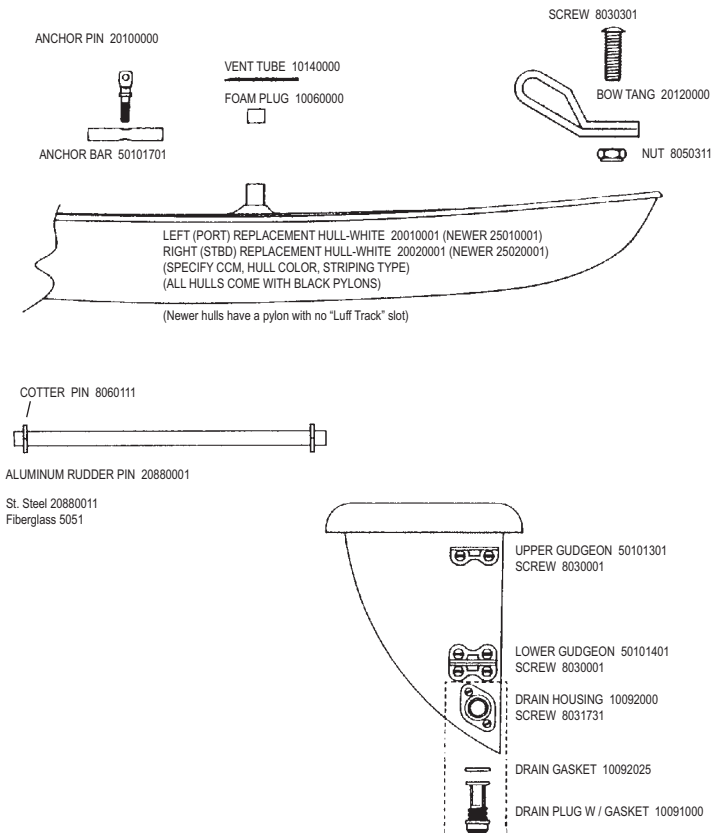

### H16 MAST

COMPLETE MAST ASSEMBLY, BLACK 20610000  
COMPTIP ASSEMBLY 20611100

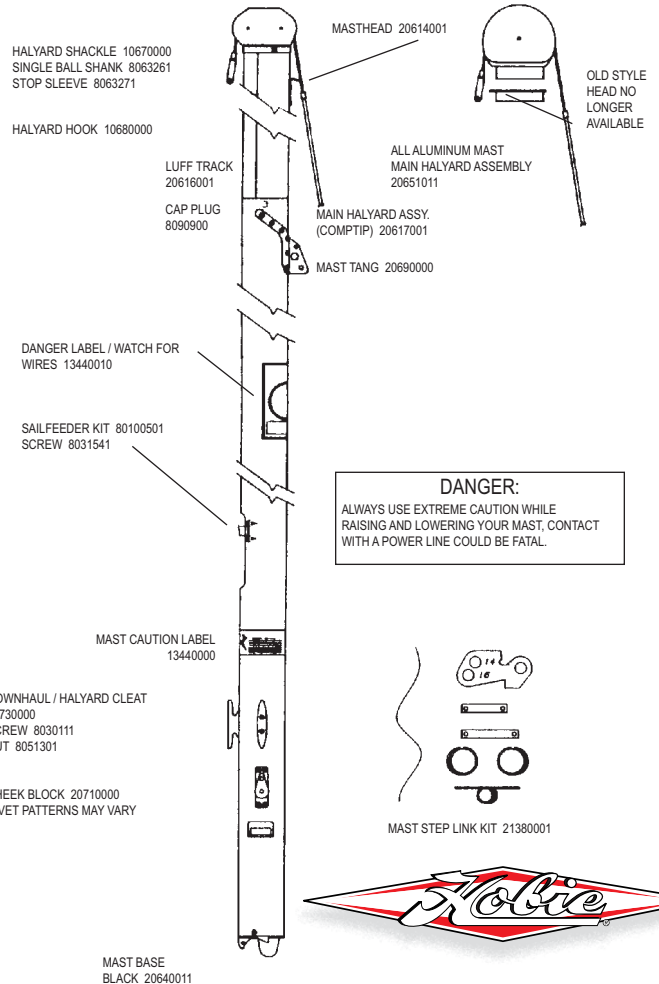



### H16 SHROUDS

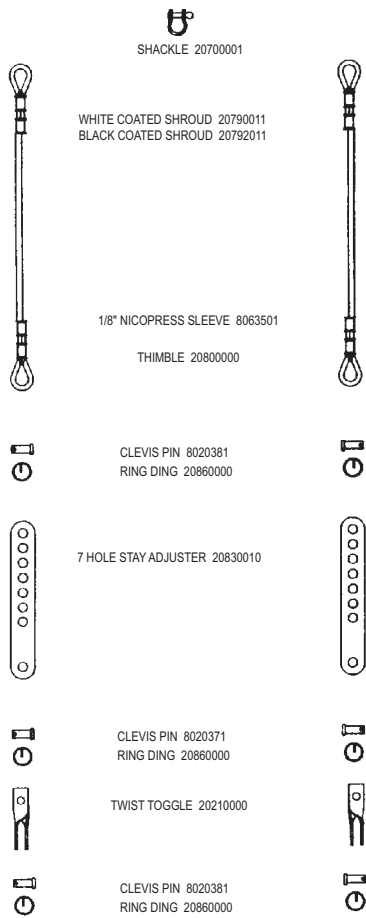

### H16 FORESTAY, JIB HALYARD, BRIDLE

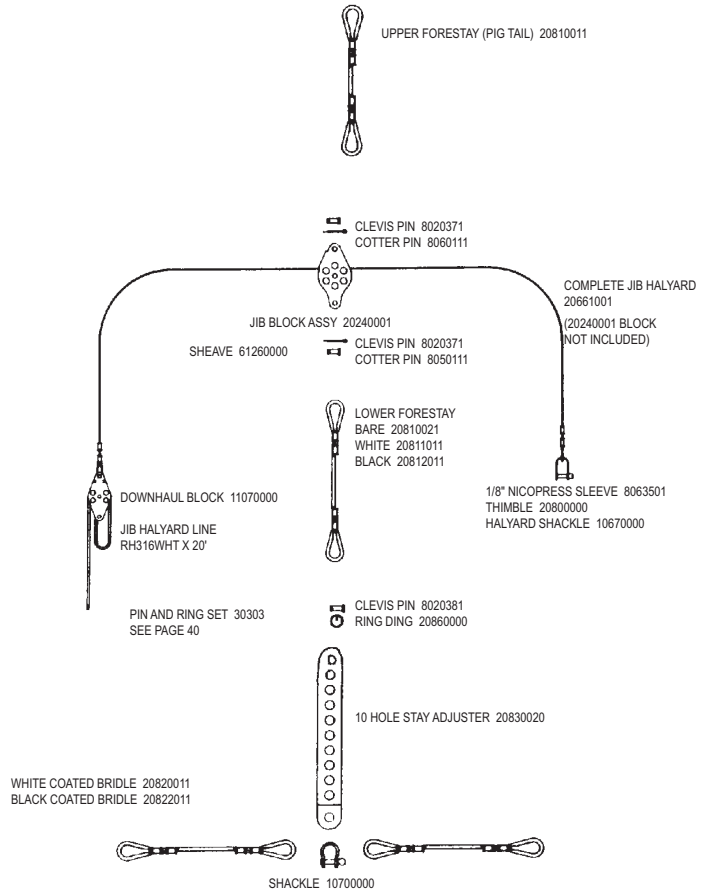

### H16 RUDDER

\* = SUB ASSEMBLY PART / INCLUDED WITH CASTING

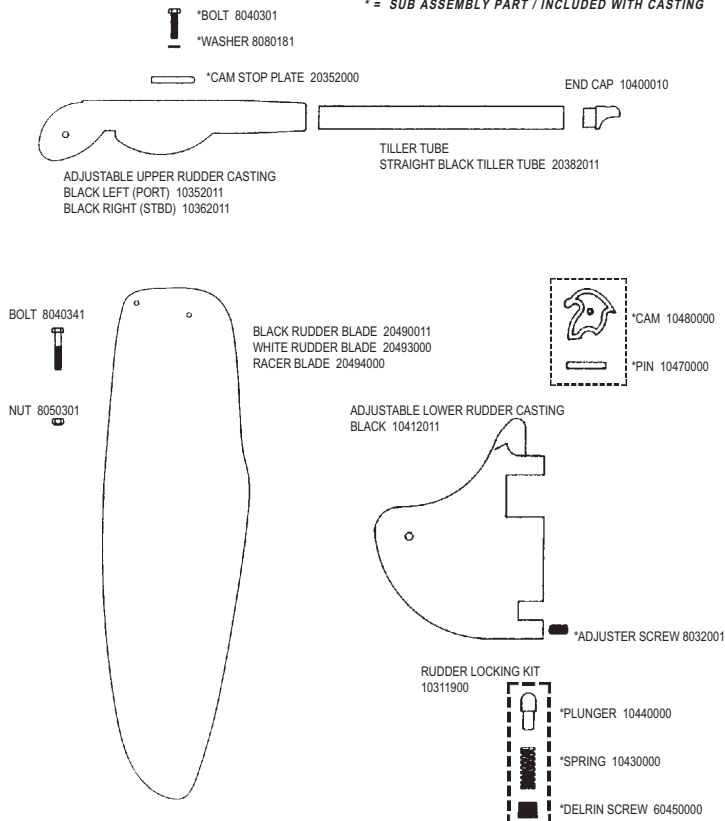

### H16 TRAPEZE

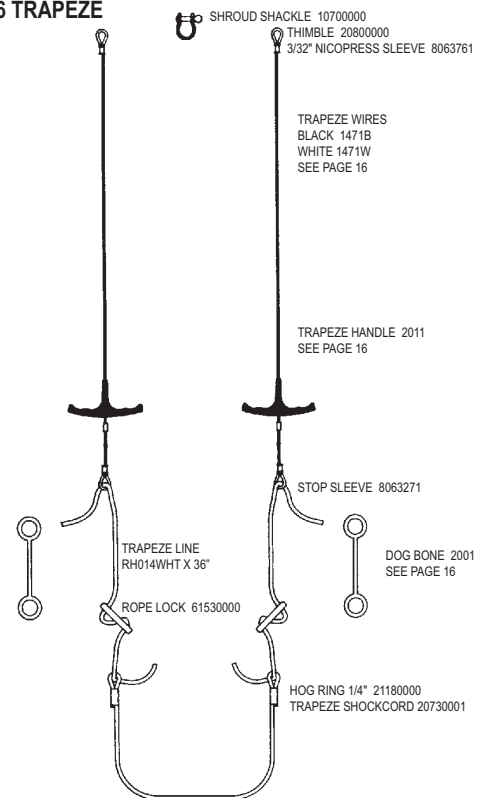

## H16 FRONT CROSSBAR

BLACK FRONT CROSSBAR W/MAST STEP / INTEGRATED TRACK 25131910

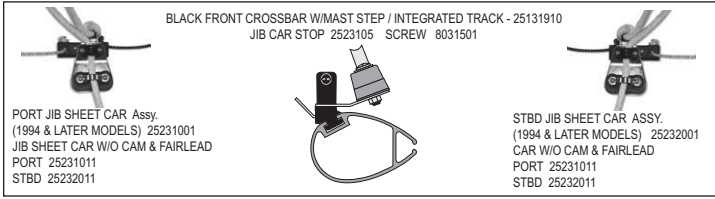

## H16 REAR CROSSBAR

ALL YEARS - BLACK REAR (AFT) CROSSBAR w/ INTEGRATED TRACK, WITHOUT CORNER CASTINGS, INCLUDES CAR ACCESS PLATE 25191911

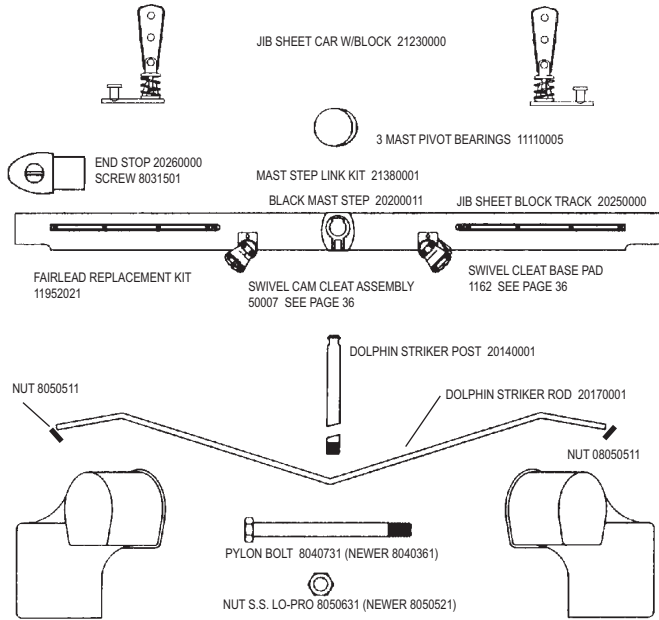
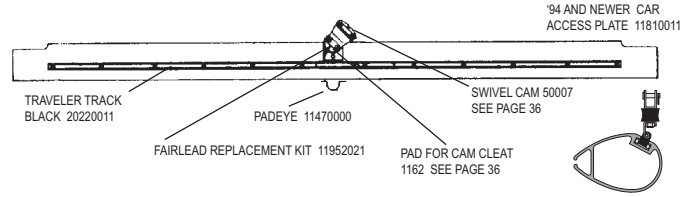

LEFT (PORT) FRONT CORNER CASTING BLACK 10150011  
(94-02") LEFT (PORT) FRONT CORNER CASTING BLACK 10152011

RIGHT (STBD) FRONT CORNER CASTING BLACK 10160011  
(94-02") RIGHT (STBD) FRONT CORNER CASTING BLACK 10162011

\* Not all '94 boats had newer style castings / pylons. In 2003 production returned to the original castings.

(94-03) FRONT CORNER CASTING JIB TRAVELER SHEAVE SHEAVE 60620000 RIVET 8011251

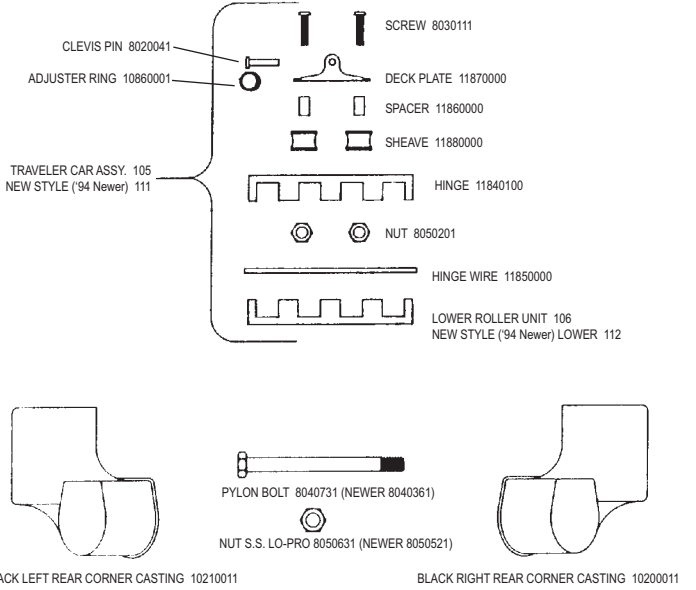

\* Not all '94 boats had newer style castings / pylons. In 2003 production returned to the original castings.

## H16 BLOCK SET

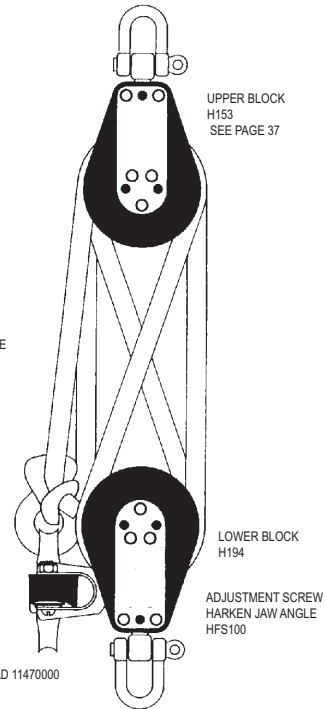

## H16 BOOM

BOOM ASSEMBLY BLACK 20720011

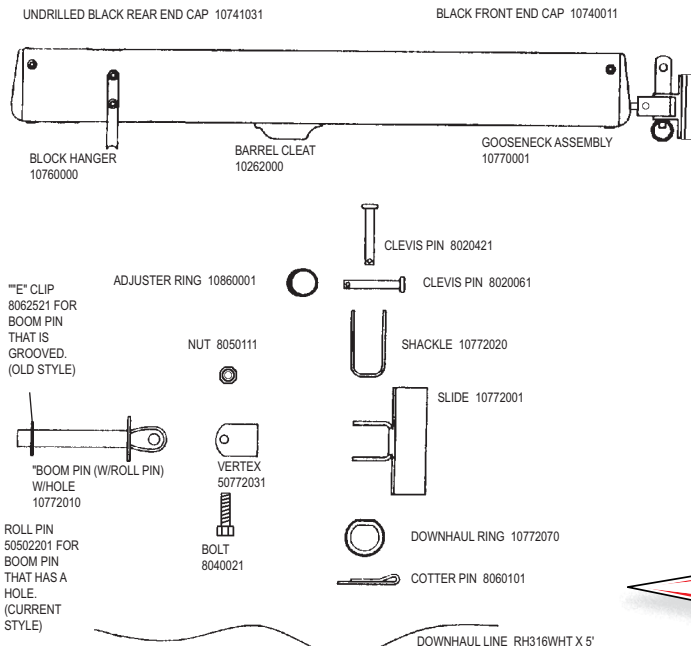

To order from your nearest HOBIE dealer call  
**1 (800) HOBIE-49**  
[www.hobiecat.com](http://www.hobiecat.com)

## H16 MAIN SAIL & BATTENS

MAIN SAIL 20991XXX  
SEE SEQUENTIAL PARTS LIST  
OR SAIL COLOR SELECTION  
SHEET, PAGE 21

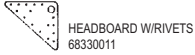

HEADBOARD W/ RIVETS  
68330011



BATTEN POCKET END PROTECTOR  
80550005



PAIR OF WHITE HOBIE LOGOS 12430001  
PAIR OF BLACK HOBIE LOGOS 12430011



CLASS INSIGNIA 22330000



SAIL WIND INDICATOR 335  
SEE PAGE 28

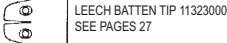

LEECH BATTEN TIP 11323000  
SEE PAGES 27



LUFF BATTEN TIP 11322011  
SEE PAGE 27



BATTEN TIE LINE  
RH112WHT X 18"

### SAIL NUMBERS

#	BLACK	WHITE
#0	12700030	12700000
#1	12710030	12710000
#2	12720030	12720000
#3	12730030	12730000
#4	12740030	12740000
#5	12750030	12750000
#6 & #9	12760030	12760000
#7	12770030	12770000
#8	12780030	12780000



CLEW/TACK PLATE SET 12240000



OUTHHAUL LINE RH316WHT X 74"

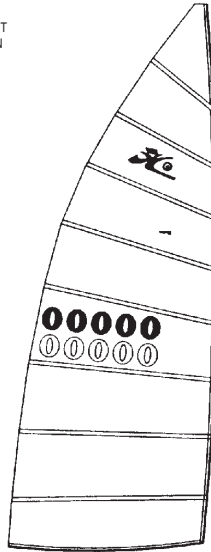

SAIL BAG/COVER 21310000



21000001 HOBIE 16 BATTEN SET  
(FOR INDIVIDUAL BATTENS SEE UNIVERSAL BATTENS ON PAGE 27)

## H16 JIB SAIL & BATTENS

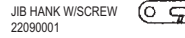

JIB HANK W/SCREW  
22090001



SAIL WIND INDICATOR  
335 SEE PAGE 28



POCKET END PROTECTOR KIT  
22080905

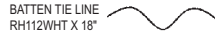

BATTEN TIE LINE  
RH112WHT X 18"



JIB SHEET LINE  
RM516XXX X 32'  
BLUE IS STOCK



BELL SHACKLE 10870000

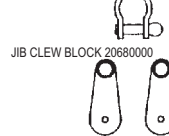

JIB CLEW BLOCK 20680000

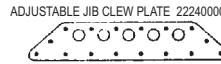

ADJUSTABLE JIB CLEW PLATE 22240000



JIB LEACH CAP 21333000

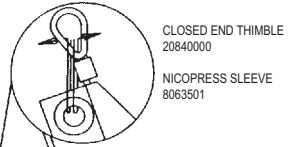

CLOSED END THIMBLE  
20840000

NICOPRESS SLEEVE  
8063501

JIB SAILS  
20992XXX  
SEE SEQUENTIAL PARTS  
LIST

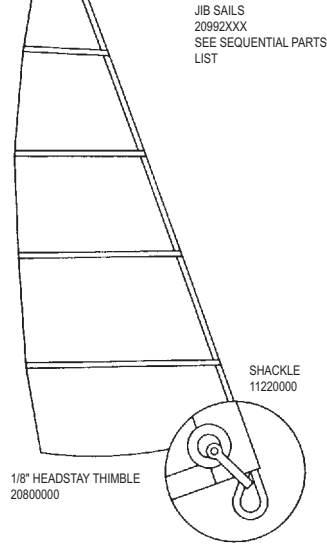

1/8" HEADSTAY THIMBLE  
20800000

SHACKLE  
11220000

JIB BATTEN SET  
20400001



FOR INDIVIDUAL BATTENS SEE  
UNIVERSAL BATTENS ON PAGE 27

## H16 TRAMPOLINE, SIDEBAR

BLACK SIDEBAR 20270011



COMPLETE TRAMPOLINE (Does not include lace line)  
WHITE 20970000  
BLACK MESH 20970055  
TEAL MESH 20970056  
BLUE MESH 20970057

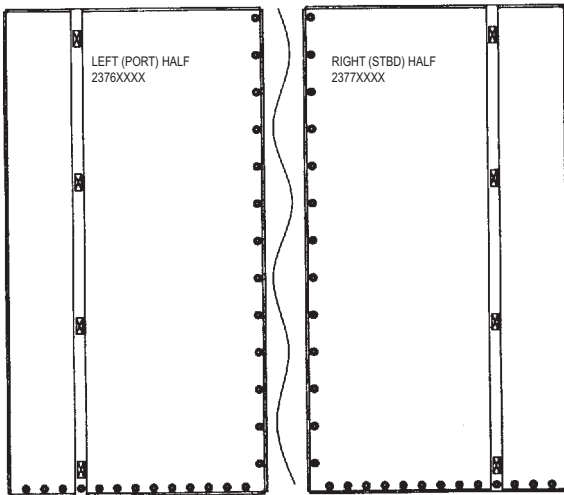

LEFT (PORT) HALF  
2376XXXX

RIGHT (STBD) HALF  
2377XXXX

CENTER LACING LINE RH014WHT X 20"

REAR (AFT) LACING LINE RH014WHT X 15"

LACING STRIP  
WHITE 13780000  
BLACK MESH 13780055  
TEAL MESH 13780056  
BLUE MESH 13780057

## H16 TILLER CROSSBAR

TILLER CONNECTOR KIT 11520005

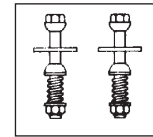

SCREW 8030111  
NUT 8050201

FIBERGLASS EXTENSION WITH HINGE 20550001

HINGE 10532010

EXTENSION TIP 10560000

RUDDER ADJUSTER KIT 60400011

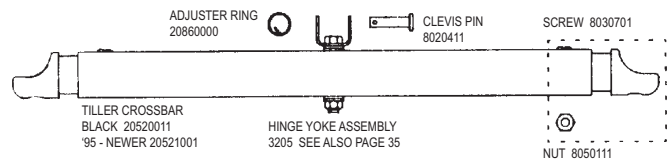

ADJUSTER RING  
20860000

CLEVIS PIN  
8020411

SCREW 8030701

TILLER CROSSBAR  
BLACK 20520011  
95 - NEWER 20521001

HINGE YOKE ASSEMBLY  
3205 SEE ALSO PAGE 35

NUT 8050111

### H17 HULL/DECK

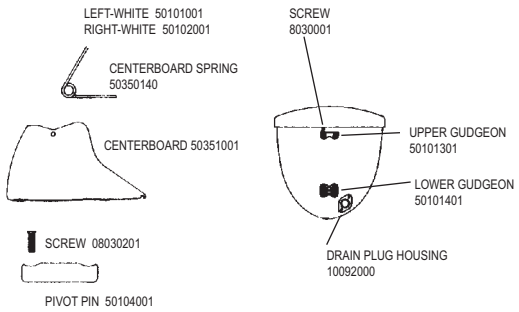

### H17 BOOM

BLACK 50510000

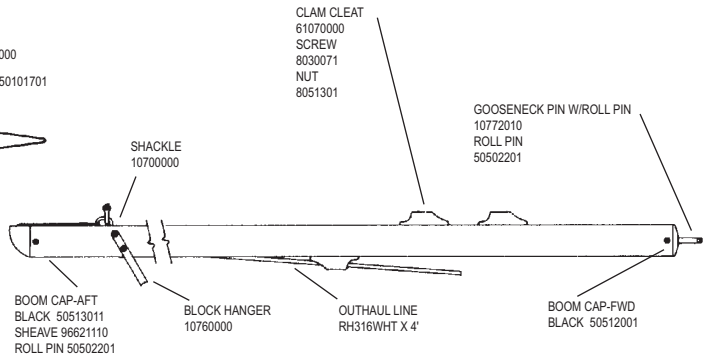
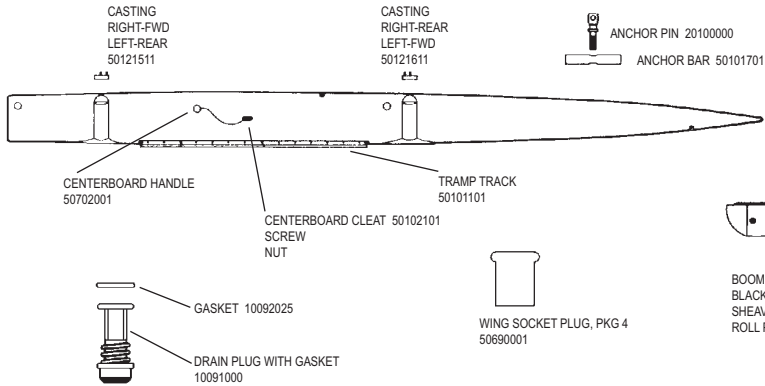
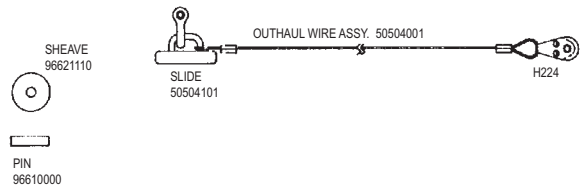

### H17 FRONT CROSSBAR

BLACK 50220000

### EXTRUSION ONLY

BLACK 50221001

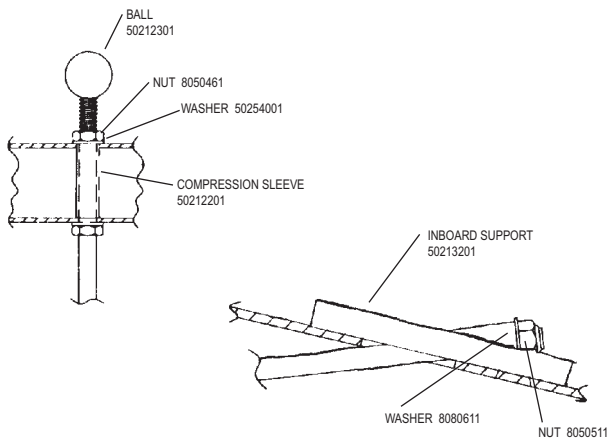

### H17 REAR CROSSBAR ASSEMBLY

CAP 50262101

BLACK 50260000

NOTE: ALL HOBIE 17 MODELS SINCE 1995 HAVE A DEEP PROFILE TRAVELER TRACK THAT ACCEPTS THE 106 OR 112 TRAVELER CAR

### EXTRUSION

BLACK 50261001

BOLT 8032221

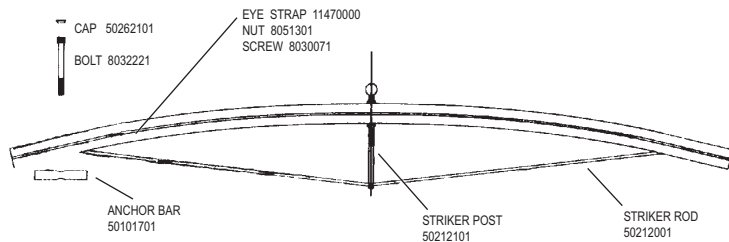
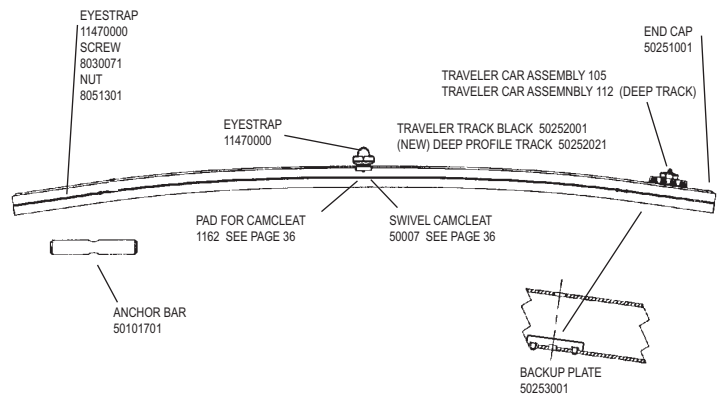

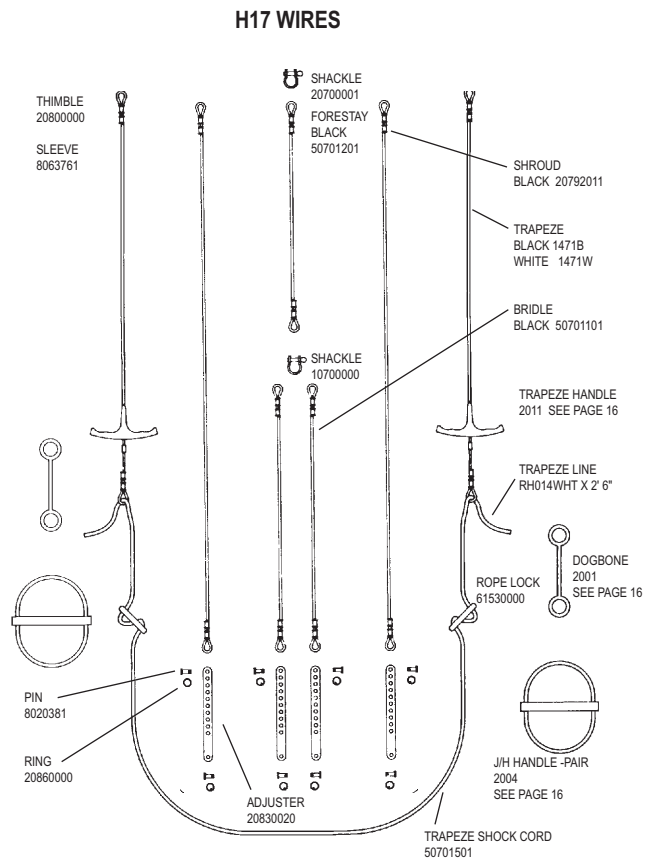
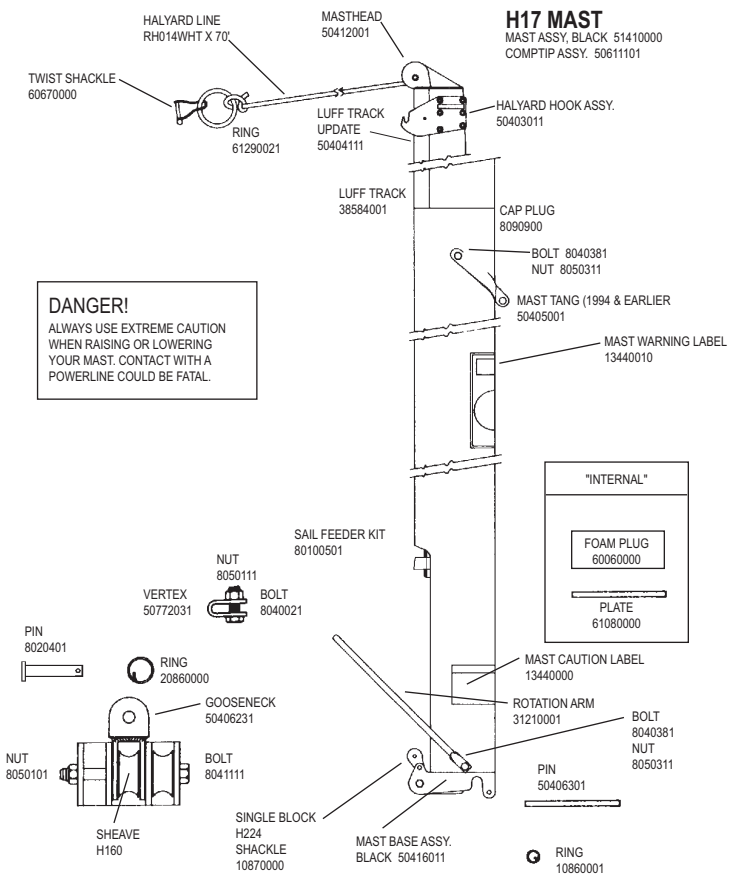

### H17 RUDDER ASSEMBLY

\* = SUB ASSEMBLY PART / INCLUDED WITH CASTING

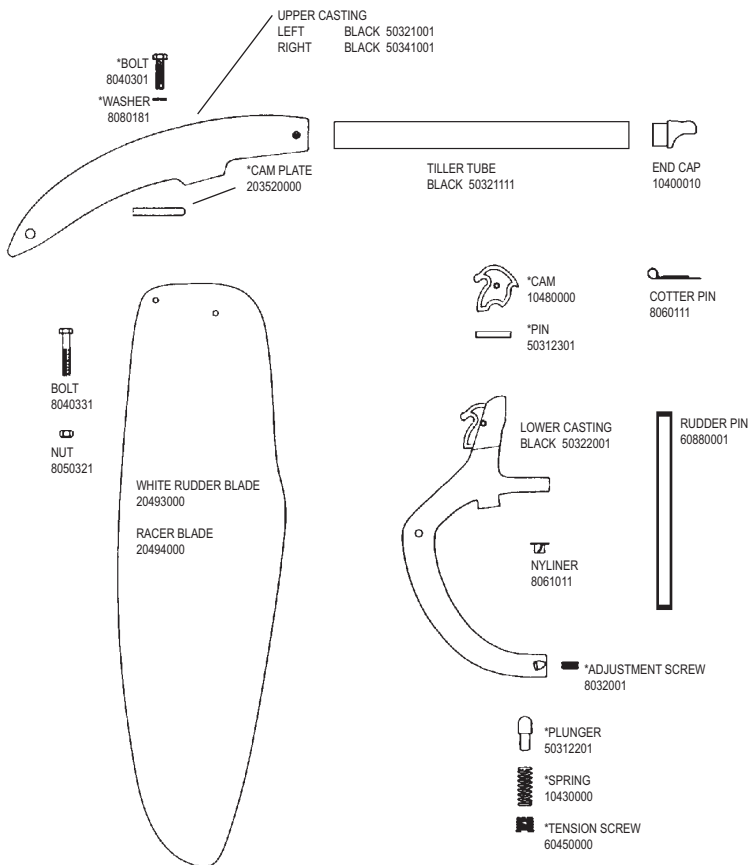

### H17 TILLER

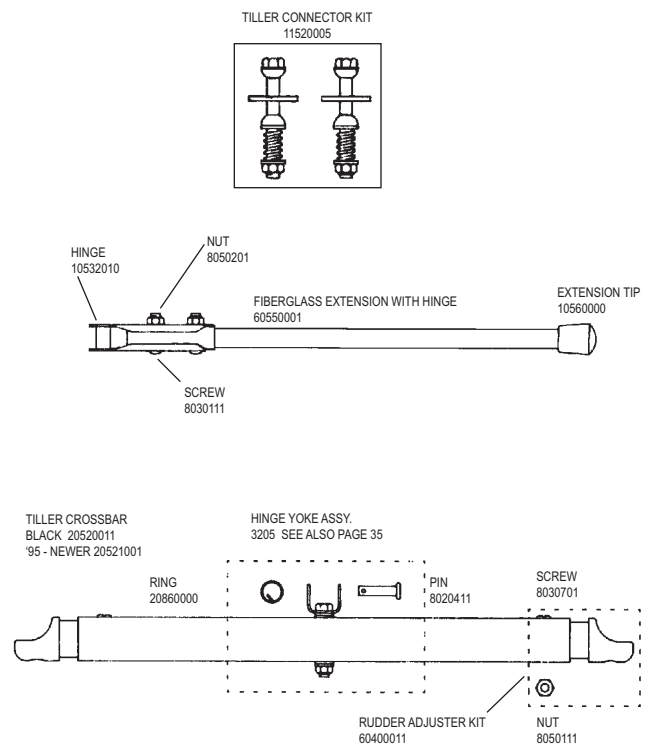

## H17 TRAMPOLINE

COMPLETE TRAMPOLINES (Does not include lace line)

WHITE 50670000  
 BLACK MESH 50670091  
 TEAL MESH 50670056  
 BLUE MESH 50670057

CENTER LACING RH014 WHT X 20'

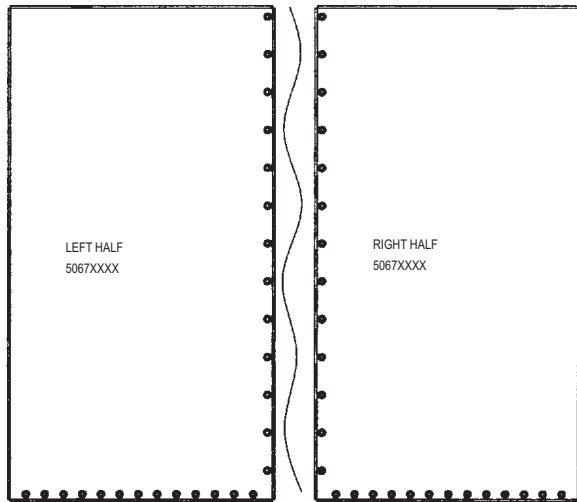

AFT LACING RH014 WHT X 15' - 2 RQD

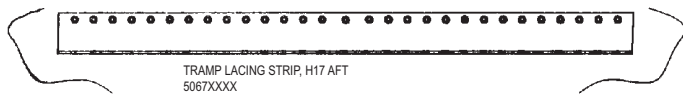

TRAMP LACING STRIP, H17 AFT  
 5067XXXX

## H17 WINGS

SET W/O TRAMPOLINES 50650000

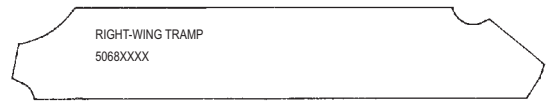

RIGHT-WING TRAMP  
 5068XXXX

WING TRAMP SET

WHITE 50650100  
 BLUE MESH 50650957  
 BLACK MESH 50650900  
 TEAL MESH 50650956

RIGHT-WING ASSY.  
 50680001

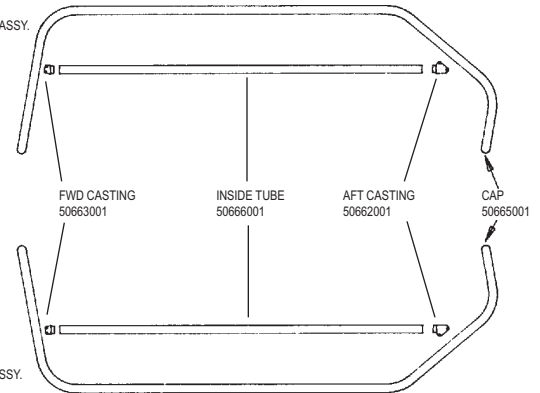

LEFT-WING ASSY.  
 50660001



LEFT-WING TRAMP  
 5066XXXX

## H17 SAIL

HEAD PLATE-SET  
 68330011

TELL TALE  
 335 SEE PAGE 28

LOGO  
 BLACK 12430011  
 WHITE 12430001

BATTEN POCKET  
 PROTECTOR KIT  
 80550005

MAIN SAIL  
 5299XXXX  
 SEE SEQUENTIAL PARTS LIST OR  
 SAIL COLOR SELECTION SHEET, PAGE 22

CLASS INSIGNIA  
 50991700

TWIST SHACKLE  
 60670000

DOUBLE BLOCK  
 H226

MAINSHEET  
 RM038XXX X 46'

CAM  
 H150

FAIRLEAD  
 11470000

CLEW PLATE-PAIR  
 62270000

#0	WHITE	12700000
#0	BLACK	12700030
#1	WHITE	12710000
#1	BLACK	12710030
#2	WHITE	12720000
#2	BLACK	12720030
#3	WHITE	12730000
#3	BLACK	12730030
#4	WHITE	12740000
#4	BLACK	12740030
#5	WHITE	12750000
#5	BLACK	12750030
#6	WHITE	12760000
#6	BLACK	12760030
#7	WHITE	12770000
#7	BLACK	12770030
#8	WHITE	12780000
#8	BLACK	12780030

DOWNHAUL LINE  
 RH316WHT X 5'

SAIL BAG  
 21310000

BATTEN TIE  
 RH112WHT X 18"



'94/OLDER SPORT	NEWER SPORT/SE
BATTEN #6 36 1/2"	BATTEN #6 36 1/2"
BATTEN #5 51 3/4"	BATTEN #5 51 3/4"
BATTEN #4 74"	BATTEN #4 74"
BATTEN #3 85 1/8"	BATTEN #3 86 1/4"
BATTEN #2 90 5/8"	BATTEN #2 93 1/4"
BATTEN #1 89"	BATTEN #1 94 3/4"

50703201 HOBIE 17 BATTEN SET  
 (FOR INDIVIDUAL BATTENS SEE UNIVERSAL BATTENS ON PAGE 27)

## H17 BLOCK SET

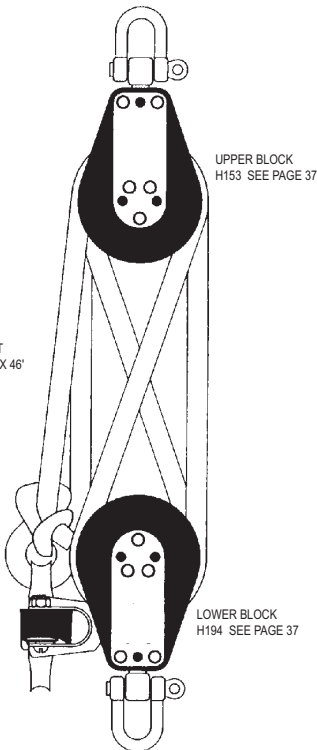

UPPER BLOCK  
 H153 SEE PAGE 37

LOWER BLOCK  
 H194 SEE PAGE 37

### H17 Rivet Guide

( ) Indicates quantity needed to fasten part

<b>Mast</b>	
Head	8010131 (2)
Halyard Hook	8011231 (3)
Base	8010131 (2)
<b>Rear Crossbar</b>	
Swivel Jammer	8010201 (1)
	8031501 (2)
	8031231 (2)
	8080011 (1)
	8050801 (1)
Dead Eye	8010181 (4)
Back Up Plate	8010201 (4)
<b>Hull</b>	
Trampoline Track	8010121 (9)
(backup washers required on above.61360000)	
<b>Boom</b>	
End Cap (gooseneck)	8010131 (2)
Block Hanger	8010181 (4)
End Cap	8010131 (2)
<b>Rudder (Upper Casting)</b>	
Casting	8011231 (4)
End Cap	8010131 (2)
<b>Sail Hardware</b>	
Headboard	8010020 (16)
Main Clew Plate	8010020 (10)
Batten Pocket	8010020 (4)
Jib Clew Plate	8010020 (8)
(above rivets require setting machine which is not available in a hand tool)	
<b>Wing</b>	
End Cap	8010051 (1)
Castings	8010131 (8)
<b>Forward Cross Bar - Sport</b>	
Swivel Cam Cleats	8010131 (4)



To order from your nearest HOBIE dealer call  
**1 (800) HOBIE-49**  
**www.hobiecat.com**

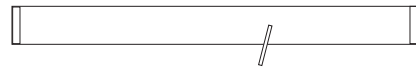

**H17 SPORT MAST ASSY. & DOWNHAUL**

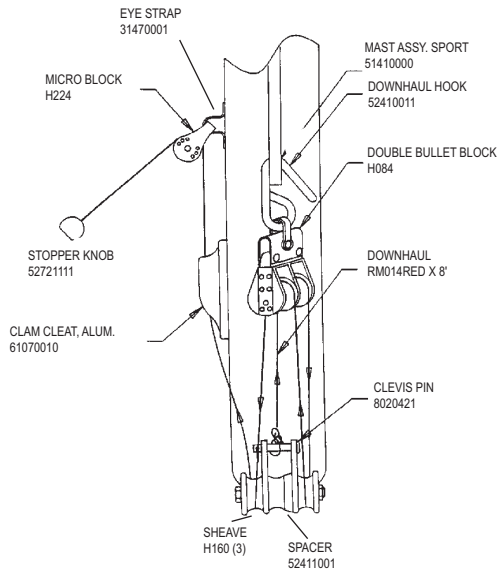

NOTE: WHERE A SPECIFIC ITEM IS NOT IDENTIFIED, USE THE STANDARD HOBBIE 17 LINE DRAWINGS.

**H17 SPORT REAR CROSSBAR, MAINSHEET SYSTEM AND OUTHAUL SYSTEM-1994 AND EARLIER**

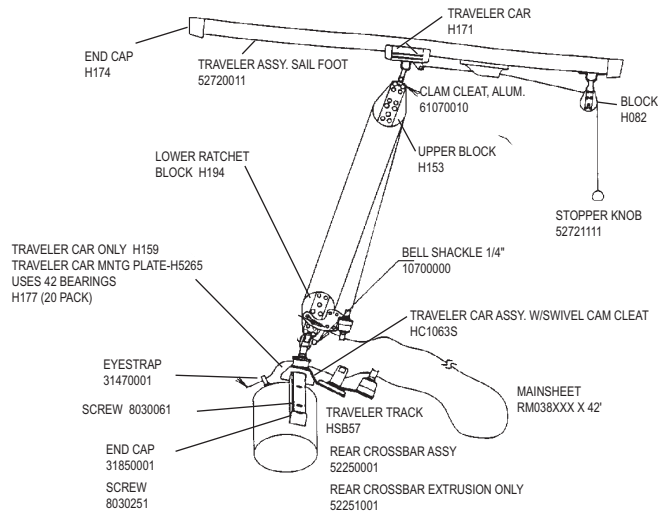

**H17 SPORT STANDARD RIGGING**

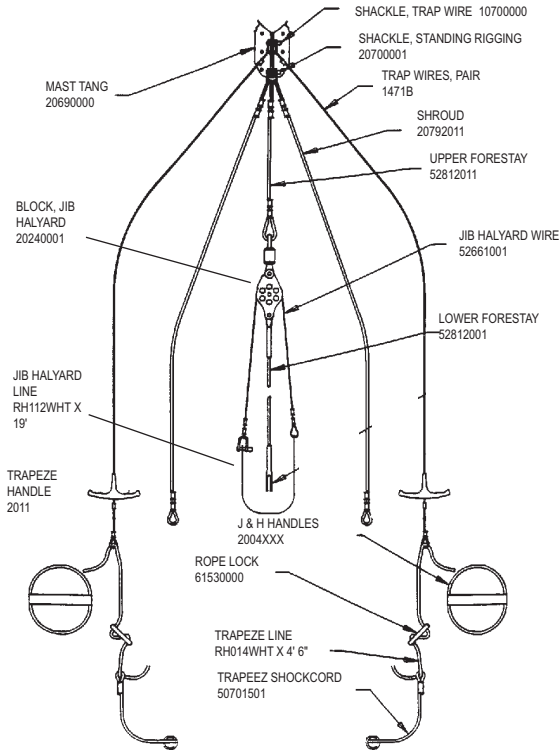

COMPLETE BATTEN SET 50703201

**BATTENS**

**H17 SPORT SPREADER POLE & FURLER**

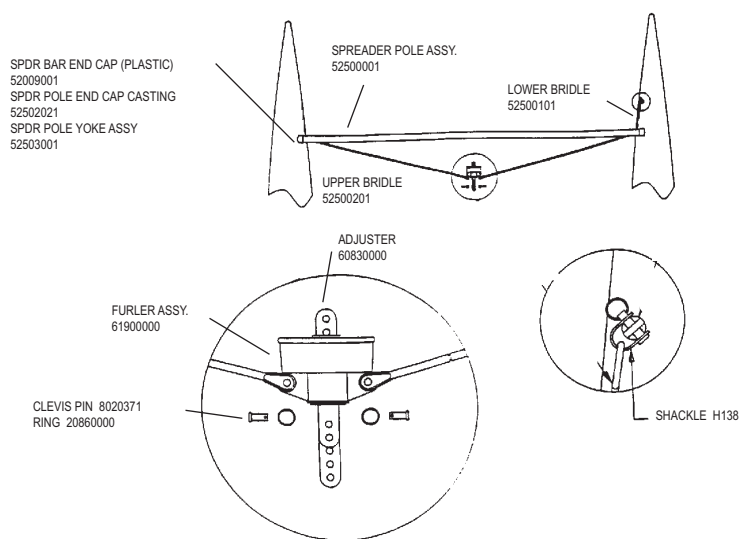

**H17 SPORT FRONT CROSSBAR**

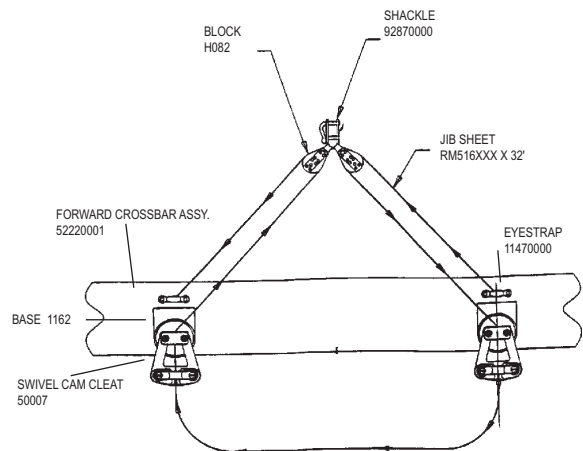

### H18 HULL/DECK

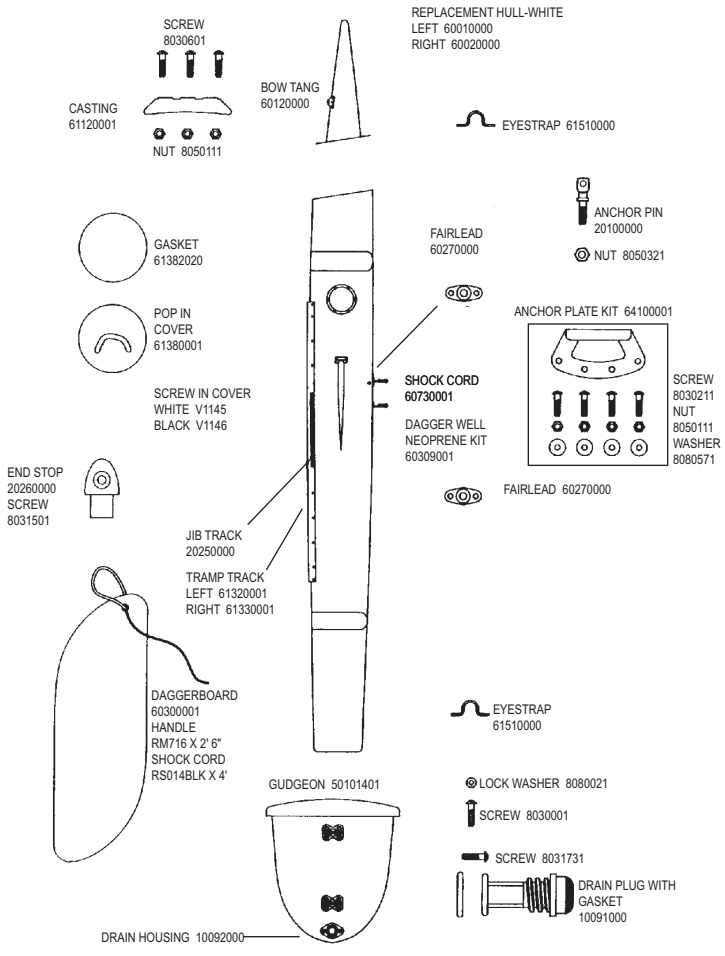

### H18 MAST

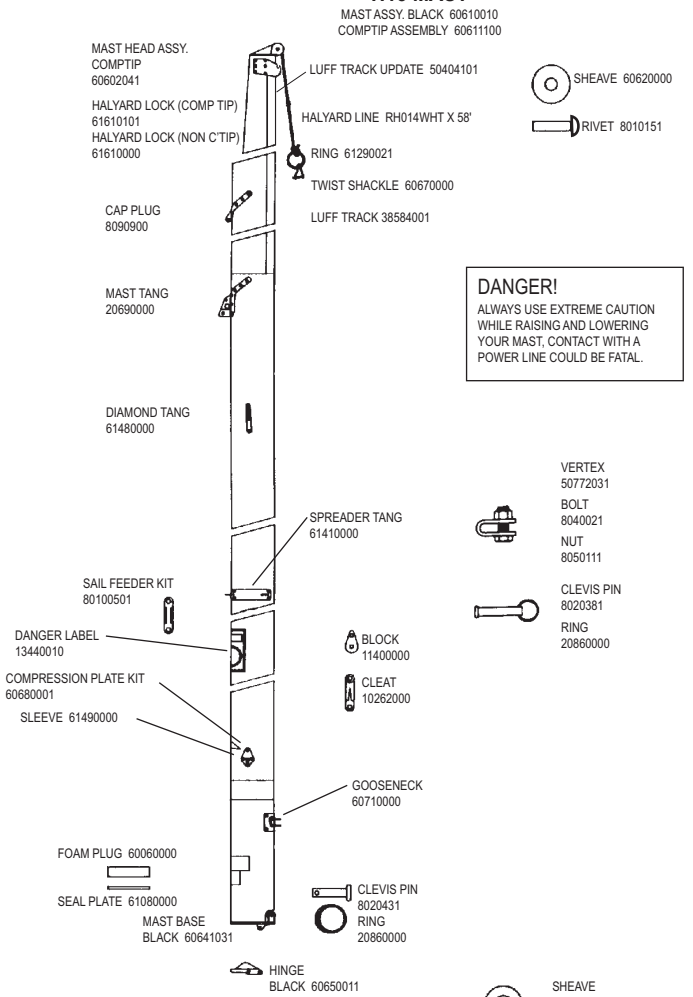

**DANGER!**  
ALWAYS USE EXTREME CAUTION WHILE RAISING AND LOWERING YOUR MAST, CONTACT WITH A POWER LINE COULD BE FATAL.

### H18 SPREADERS

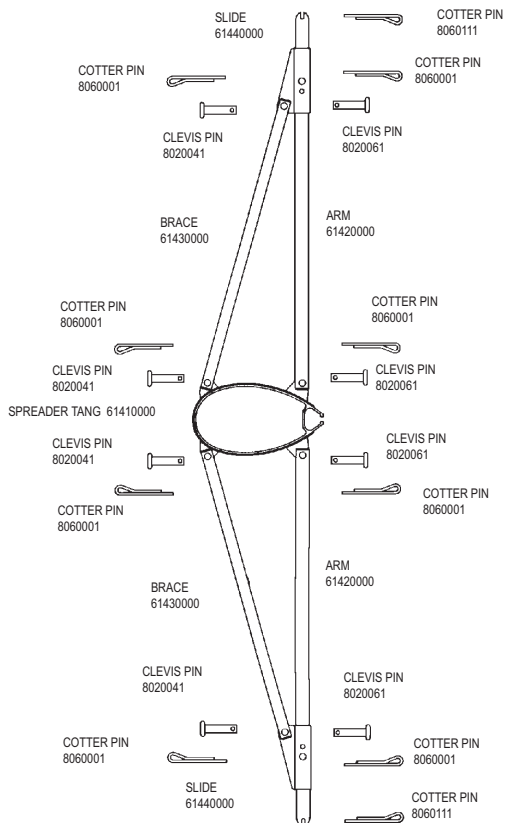

### H18 DIAMOND WIRES, ROTATION ARM

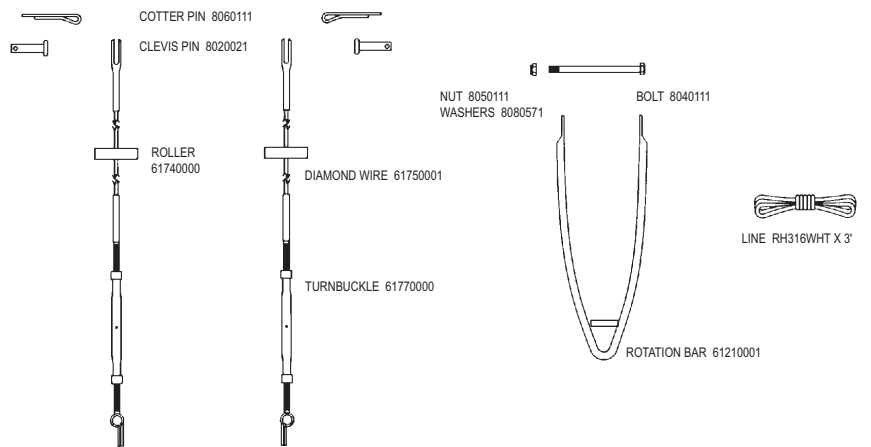



# H18 SHROUDS & ADJUSTERS

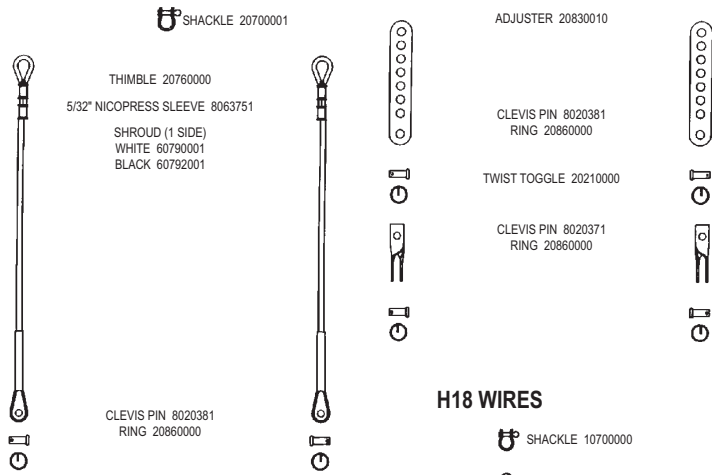

# H18 FORESTAY & JIB HALYARD

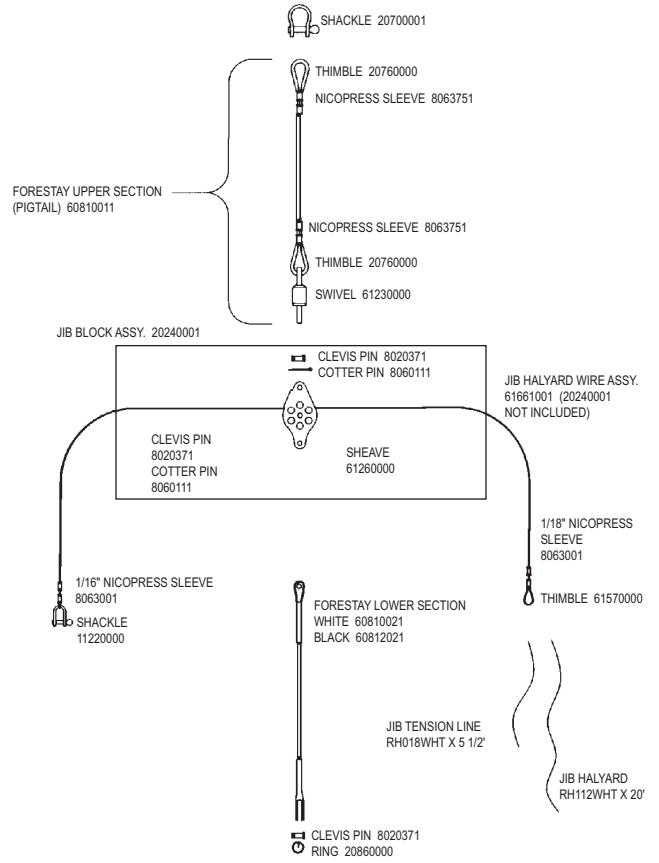

# H18 WIRES

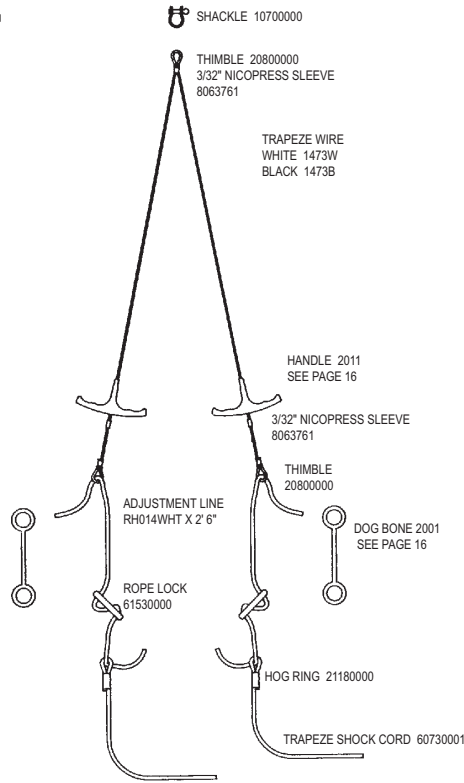

# H18 ROLLER FURLER & BRIDLES

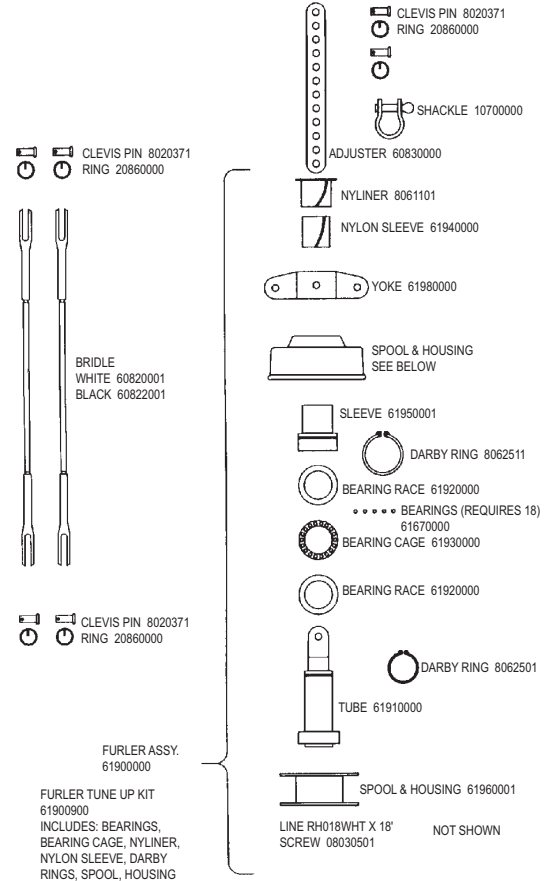

# H18 TRAMPOLINE

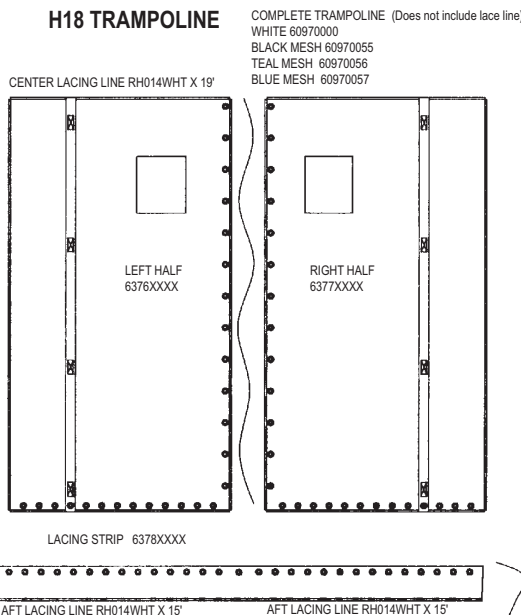

H18 RIVET GUIDE	
( ) Indicates quantity needed to fasten part.	
<b>MAST</b>	
HEAD	8010131 (2)
HALYARD HOOK	8011231 (6)
TANG	8010181 (12)
DIAMOND TANG	8010181 (3)
SPREADER TANG	8010181 (8)
COMPRESSION PLATE	8010181 (4)
GOOSENECK PLATE	8010131 (2)
GOOSENECK CLEAR	8010131 (2)
GOOSENECK BLOCK	8010131 (2)
BASE	8010131 (2)
(Note: all 8010181 mast rivets require 08011291 rivet caps)	
<b>REAR CROSSBAR</b>	
CORNER CASTING	8011231 (6)
INBOARD SUPPORT	8010131 (2)
SWIVEL JAMMER	8010201 (1)
	8031501 (2)
	8031231 (1)
	8080011 (1)
	8050801 (1)
DEAD EYE	8010181 (4)
<b>HULL</b>	
TRAMPOLINE TRACK (backup washers required on above, 61360000)	8010121 (9)
ACCESS PORT FLANGE	8010901 (12)
EYE STRAP	8010131 (2)
<b>BOOM</b>	
END CAP	8010131 (2)
<b>FRONT CROSSBAR</b>	
MAST STEP	8010131 (4)
CORNER CASTING	NONE USED
INBOARD SUPPORT	8010131 (2)
JAM CLEAT	8010181 (2)
<b>RUDDER (UPPER CASTING)</b>	
CASTING	8011231 (3)
END CAP	8010131 (2)
<b>SAIL HARDWARE</b>	
HEADBOARD	8010020 (16)
MAIN CLEW PLATE	8010020 (10)
BATTEN POCKET	8010020 (4)
JIB CLEW PLATE	8010020 (6)
(above rivets requires setting machine which is not available in a hand tool.)	

### H18 FWD CROSSBAR

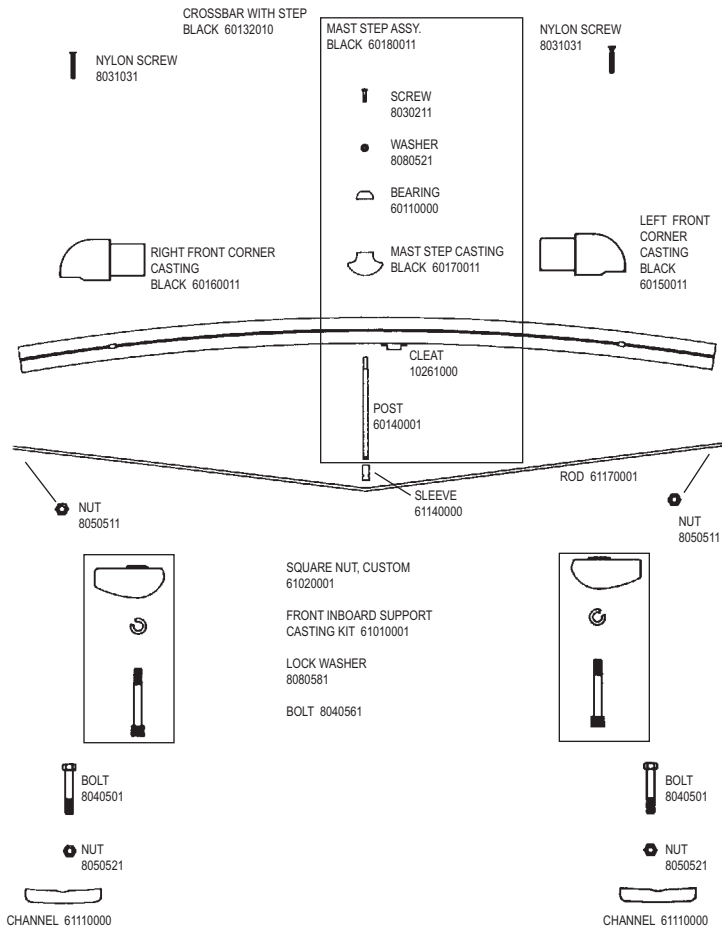

### H18 REAR CROSSBAR

REAR CROSSBAR - EXTRUSION ONLY  
BLACK 60191211

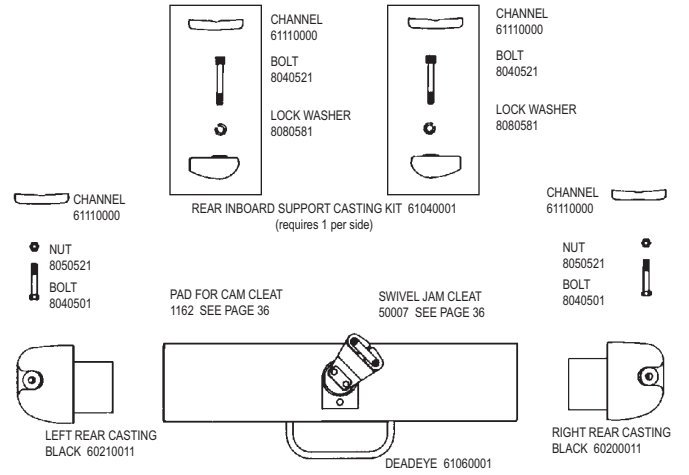

### H18 BOOM

OUTHAUL CAR ASSY 60220001 (OUTHAUL AND SHOCK CORD NOT INCLUDED)

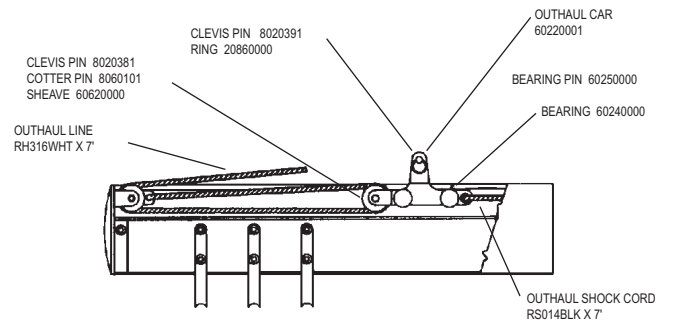

### H18 BLOCK SET WITH LINE

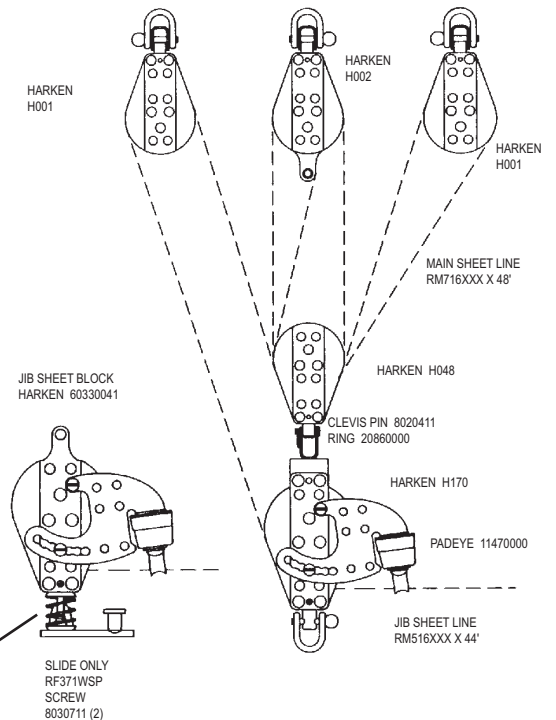
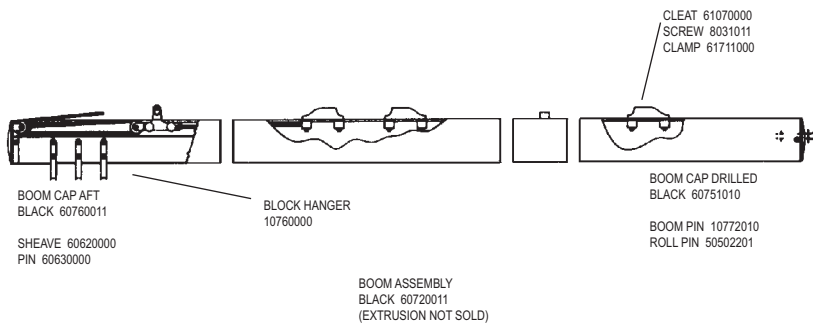

- TRAVELER  
61800001
- BOLT 8040301
  - DECK PLATE 61870000
  - SPACER 61880000
  - SHEAVE 61890000
  - NUT 8050311
  - CAR SUB ASSY. 61842000
  - COTTER PIN 8060121
  - ROLLER SKID 61810000
  - BUSHING SHAFT 61830000
  - BEARING SET 61852000
  - CLEVIS PIN 8020431



To order from your nearest HOBIE dealer call  
**1 (800) HOBIE-49**  
[www.hobiecat.com](http://www.hobiecat.com)

# H18 RUDDER ASSEMBLY

\* = SUB ASSEMBLY PART / INCLUDED WITH CASTING

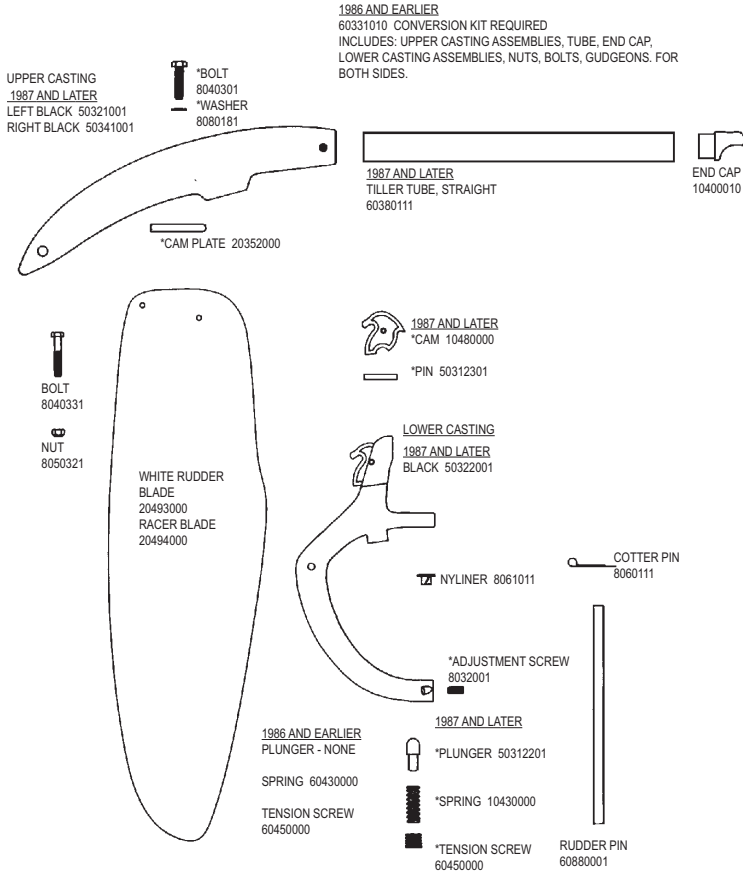

# H18 TILLER CROSSBAR & EXTENSION

TILLER CONNECTOR KIT 11520005

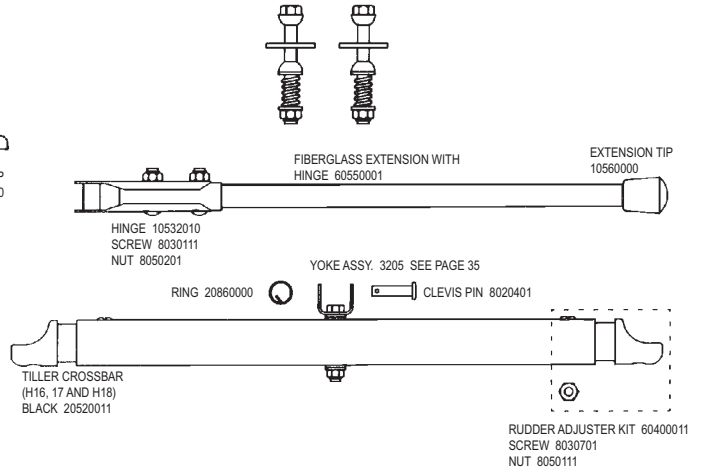

# SX18 WINGS

WING SET W/O TRAMPOLINES 68001000

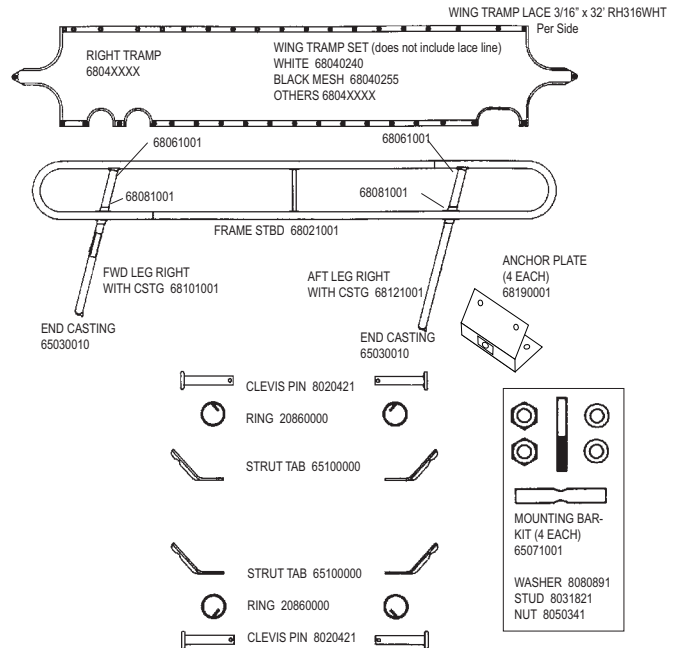

# H18 MAIN SAIL & BATTENS

60991XXX H18 MAIN SAIL SEE NUMERICAL SECTION  
OR SAIL COLOR SELECTION SHEETS, PAGE 21

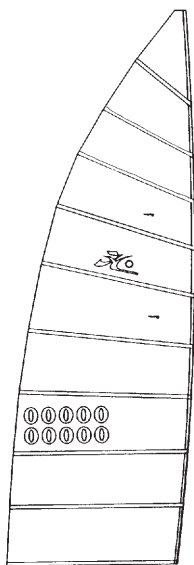
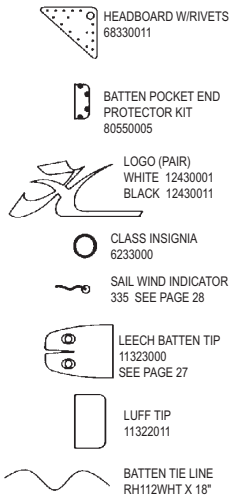

14" SAIL NUMBERS

	BLACK	WHITE
#1	12710030	12710000
#2	12720030	12720000
#3	12730030	12730000
#4	12740030	12740000
#5	12750030	12750000
#6&9	12760030	12760000
#7	12770030	12770000
#8	12780030	12780000
#0	12700030	12700000

SAIL BAG 21310000

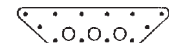

HOBIE 18	HOBIE 18SX
BATTEN #10 24 1/8"	BATTEN #9 28 1/2"
BATTEN #9 39 1/16"	BATTEN #8 46 1/8"
BATTEN #8 56 5/16"	BATTEN #7 67 7/8"
BATTEN #7 68 13/16"	BATTEN #6 83 5/16"
BATTEN #6 79 5/16"	BATTEN #5 93 7/8"
BATTEN #5 87 5/16"	BATTEN #4 100 9/16"
BATTEN #4 93 7/8"	BATTEN #3 103 3/4"
BATTEN #3 97 5/16"	BATTEN #2 104 11/16"
BATTEN #2 101 5/16"	BATTEN #1 102 11/16"
BATTEN #1 101 5/16"	

62000001 HOBIE 18 BATTEN SET / 68000001 H18SX BATTEN SET  
(FOR INDIVIDUAL BATTENS SEE UNIVERSAL BATTENS ON PAGE 27)

FOR HOT STICK SEE FX6  
FOR MAG TILLER STD SIZE  
SEE PIN 65050000

SX WINGS PARTS KIT  
68060101  
(EVERYTHING EXCEPT  
WINGS, TRAMPS, LINES  
AND EXTENSION)

## H2O MIRACLE HULL/DECK

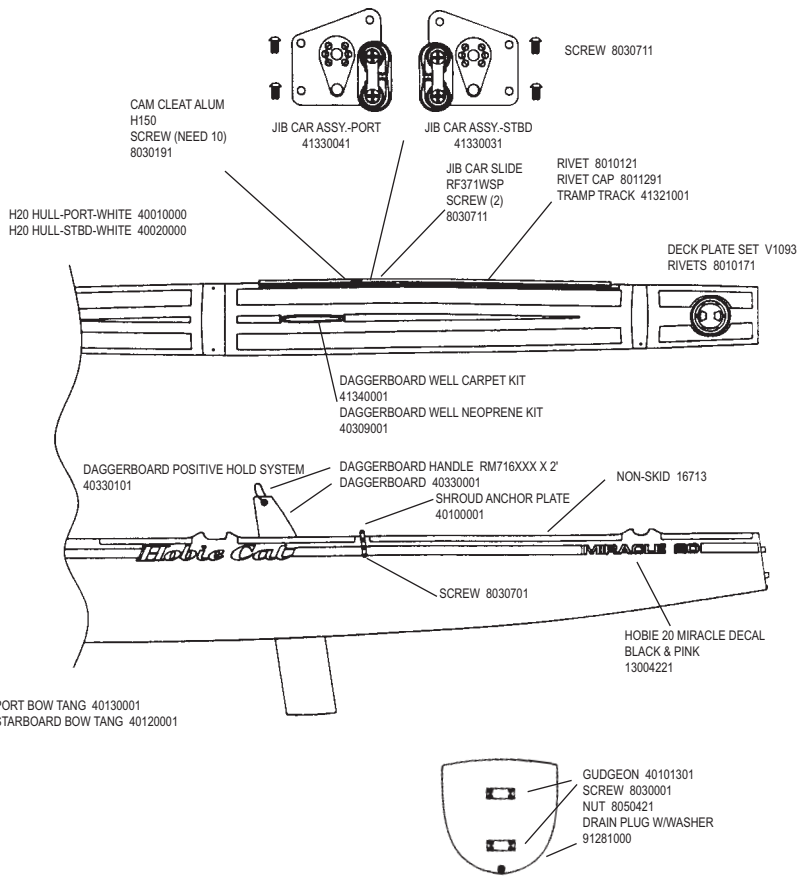

## H2O MIRACLE MAST

MAST ASSY. 40581000  
COMPTIP 40401210

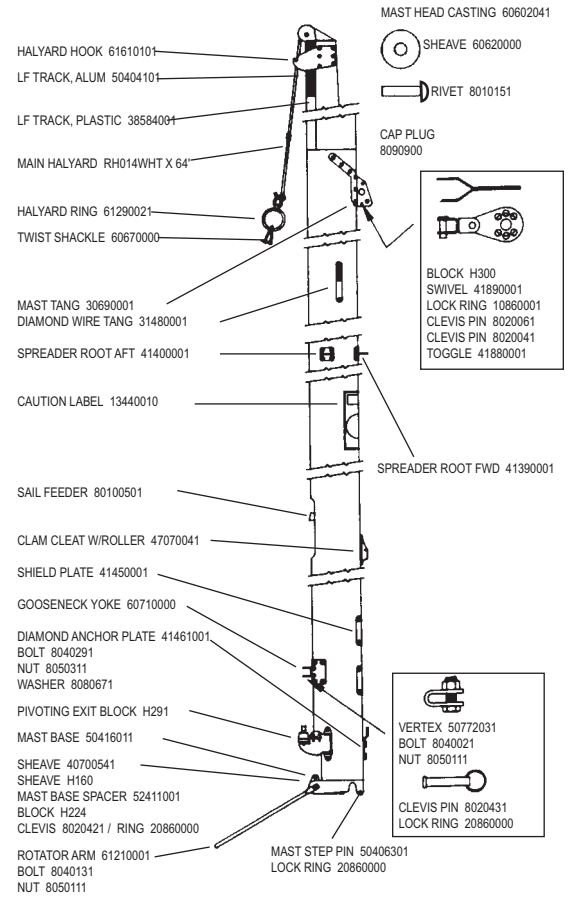

## H2O MIRACLE SPREADER & DIAMOND WIRE SYSTEM

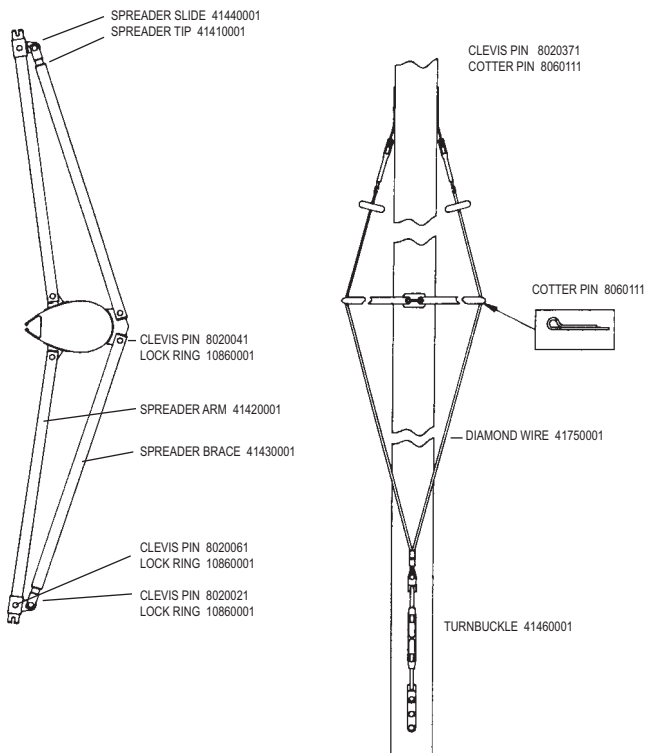

## H2O MIRACLE MAST ROTATION CONTROLS

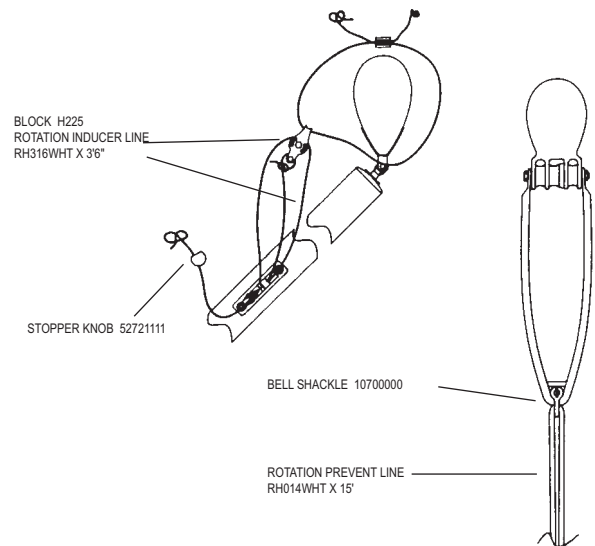

## H2O MIRACLE FORESTAY AND JIB HALYARD

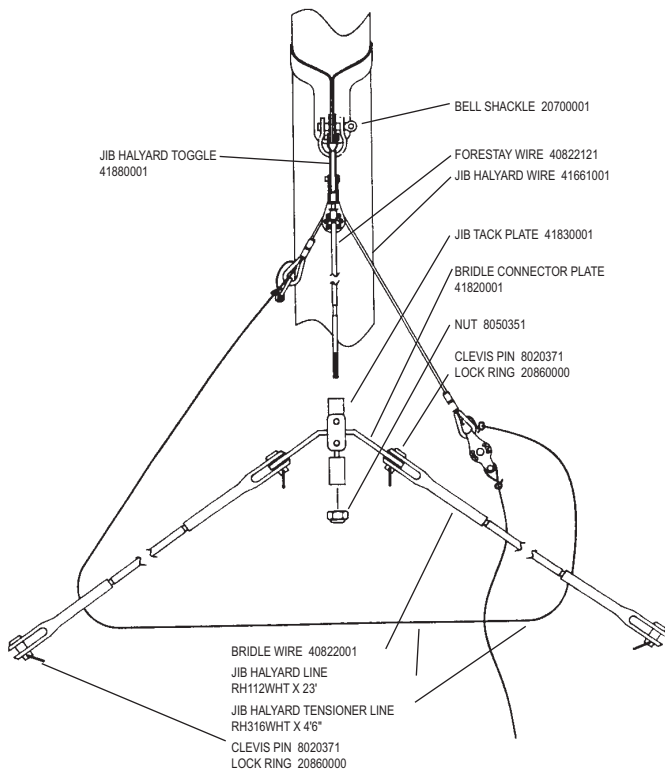

## H2O MIRACLE SHROUDS AND TRAPEZE

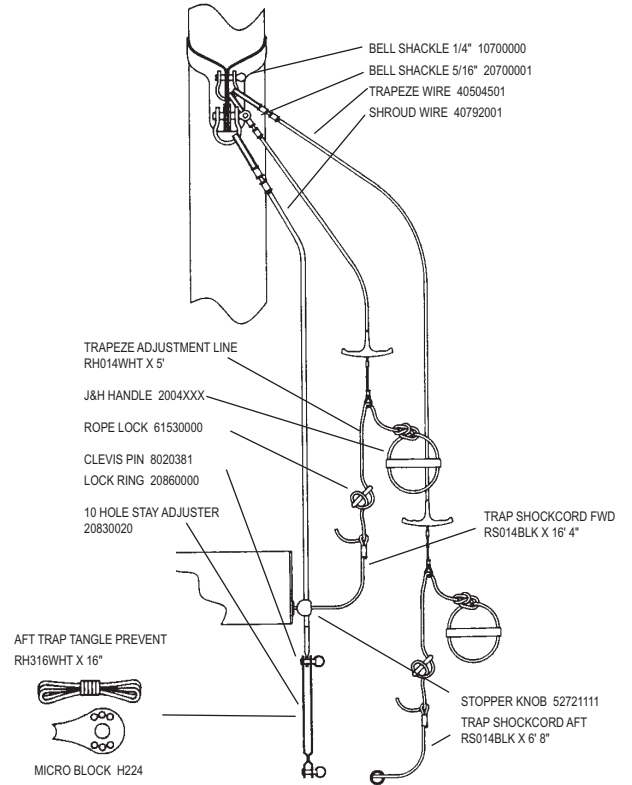

## H2O MIRACLE TRAMPOLINE

(Does not include lace line or hiking straps)

TRAMPOLINE BLACK MESH 40970055  
 TRAMPOLINE TEAL MESH 40970056  
 TRAMPOLINE BLUE MESH 40970057

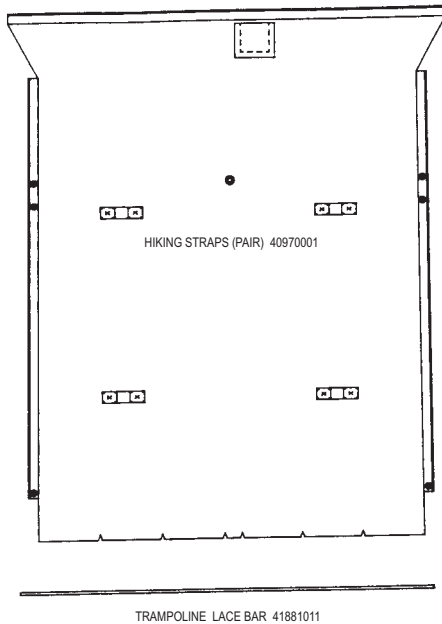

TRAMPOLINE LACE BAR 41881011



HIKING STRAP LINE RH014WHT X 5'



TRAMPOLINE LACE LINE RH316WHT X 15'

SEE REAR CROSS BAR FOR LACING EYELETS

## H2O MIRACLE JIB FURLING KIT

COMPLETE FURLING KIT 48921001

\* = (Shown as replacement part, Not included in kit)

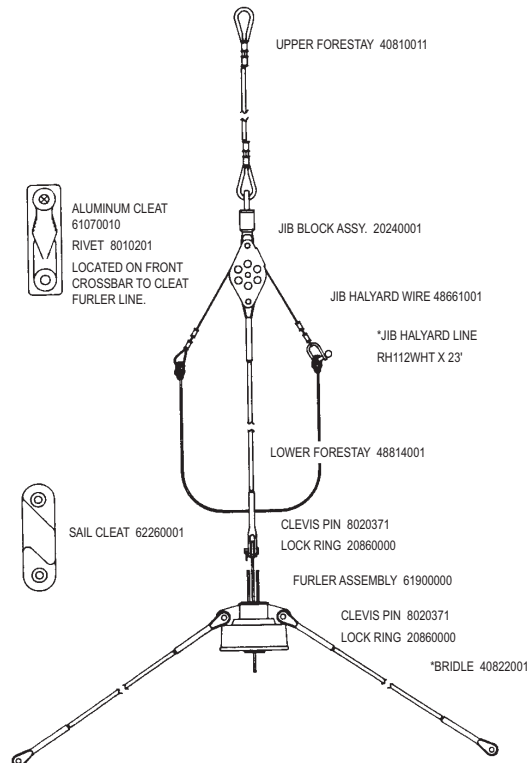

## H2O MIRACLE FRONT CROSSBAR

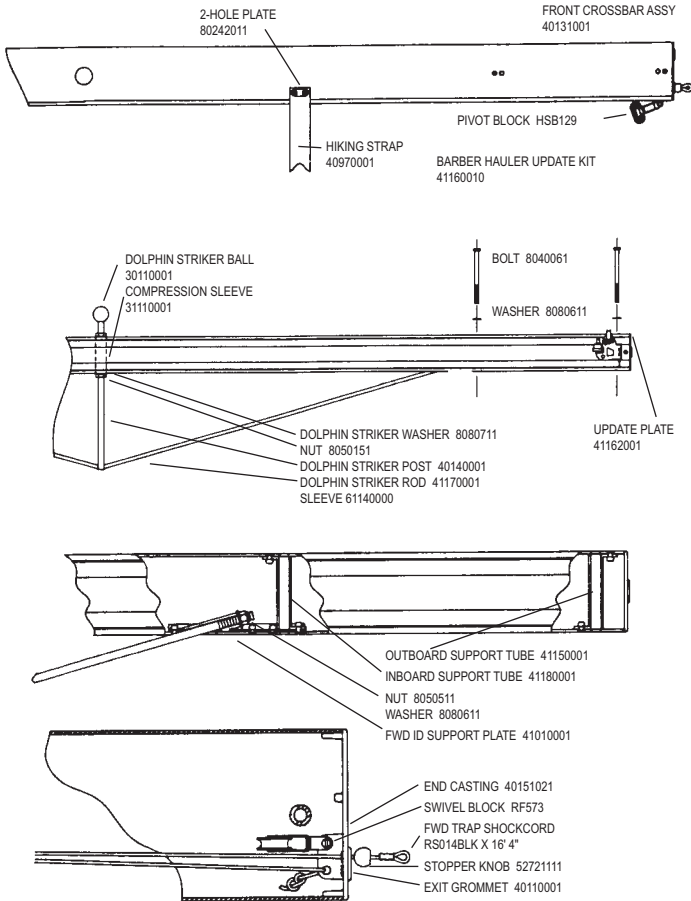

## H2O MIRACLE REAR CROSSBAR

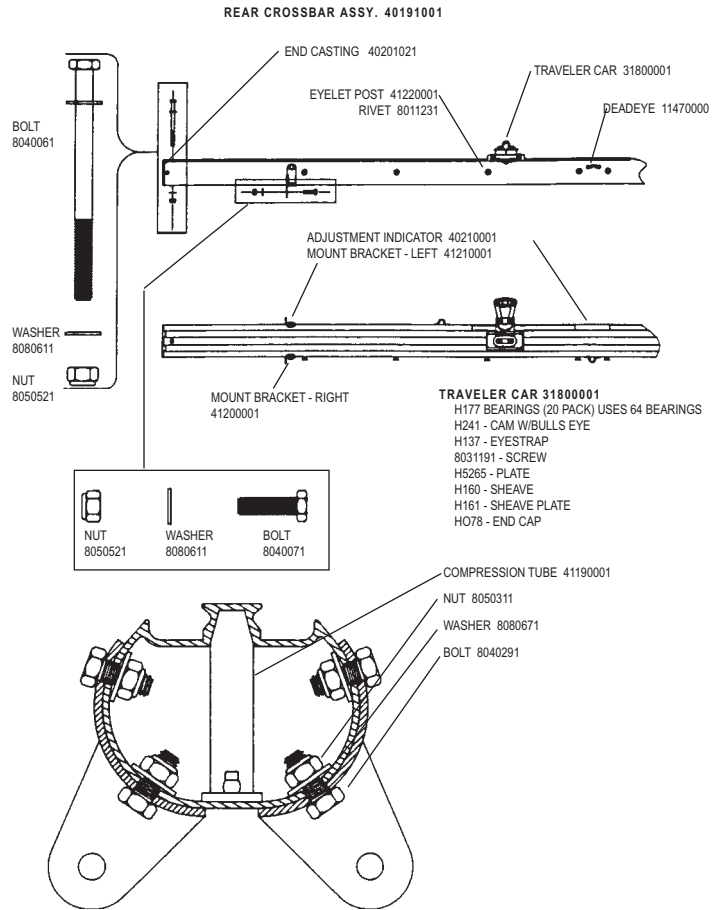

## H2O MIRACLE MAINSHEET SYSTEM

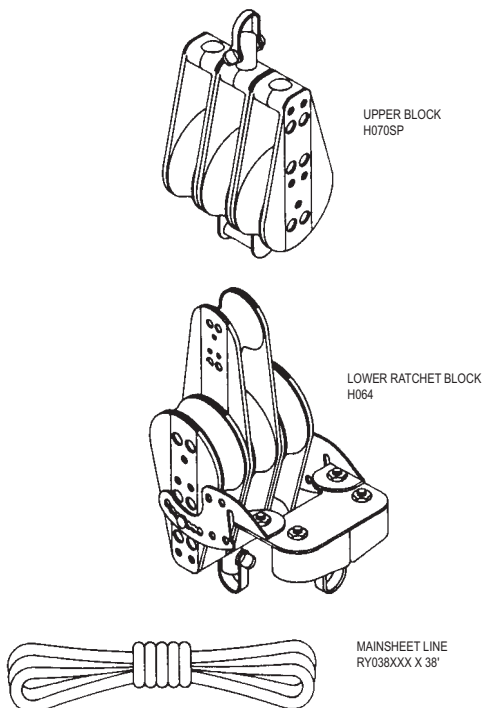

## H2O MIRACLE BOOM

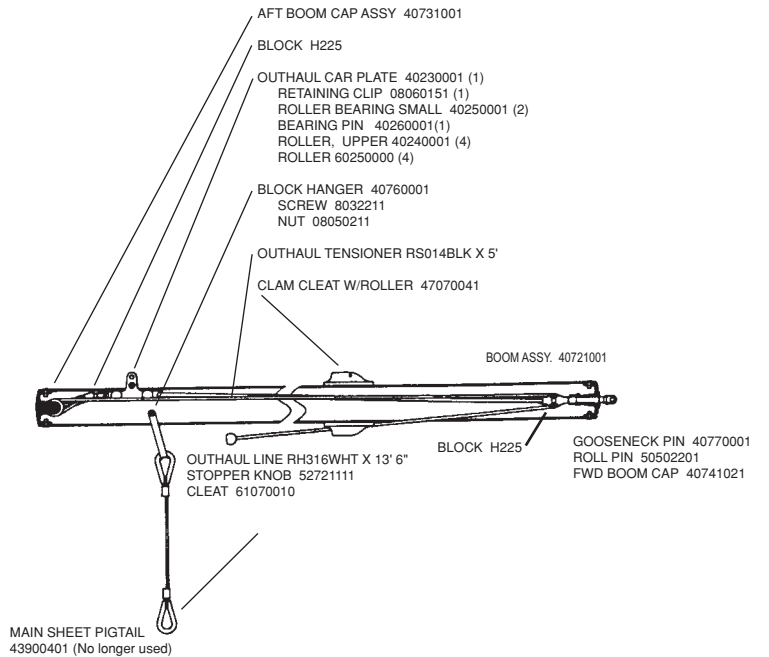

To order from your nearest HOBIE dealer call  
**1 (800) HOBIE-49**  
[www.hobiecat.com](http://www.hobiecat.com)

## H2O MIRACLE JIB SYSTEM

### H2O MIRACLE TILLER CROSSBAR AND EXTENSION

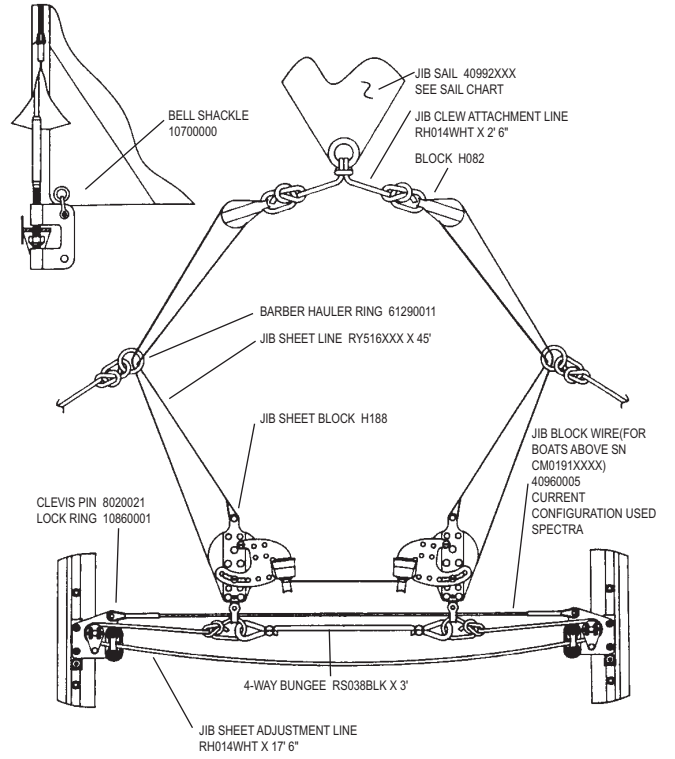
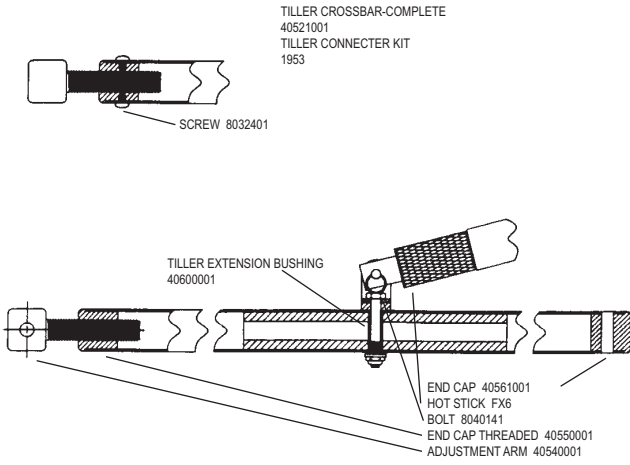

### H2O MIRACLE MAIN SAIL AND BATTENS

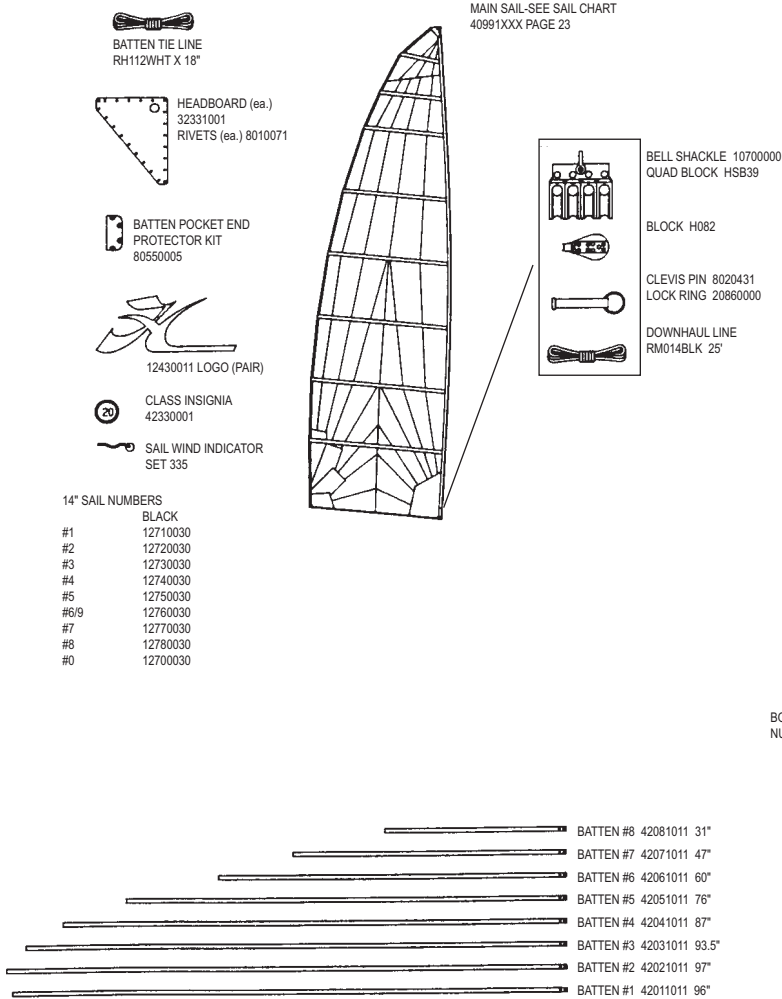

COMPLETE BATTEN SET 42001011

### H2O MIRACLE RUDDER

